

a·emotional light

Index

Índice

TABLE LAMPS | LÁMPARAS DE MESA

16 - 20

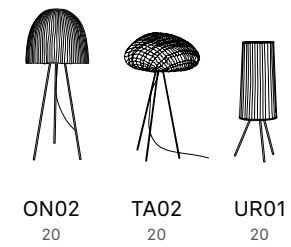
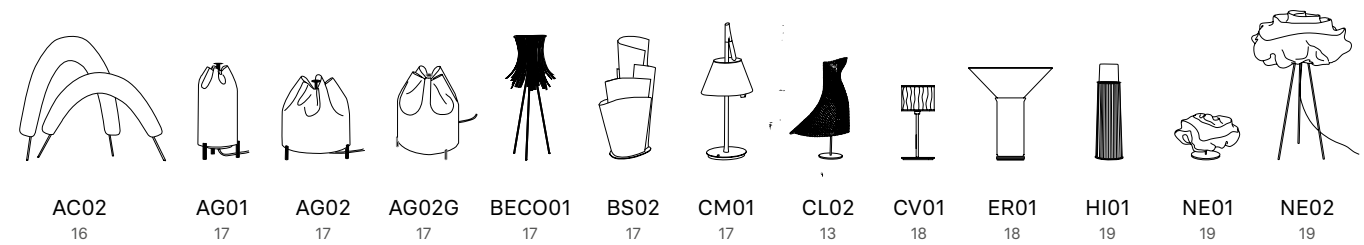

FLOOR LAMPS | LÁMPARAS DE PIE

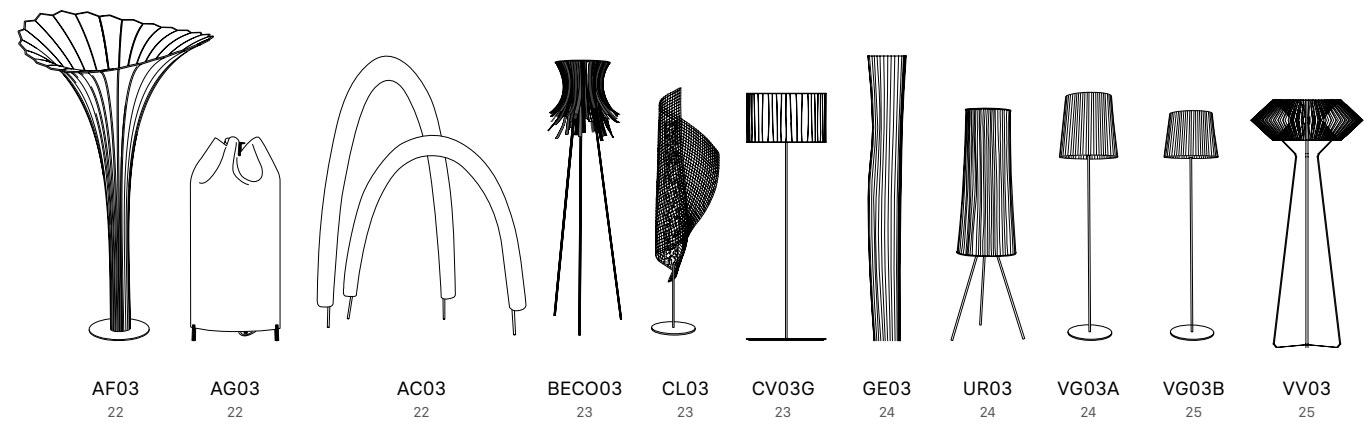

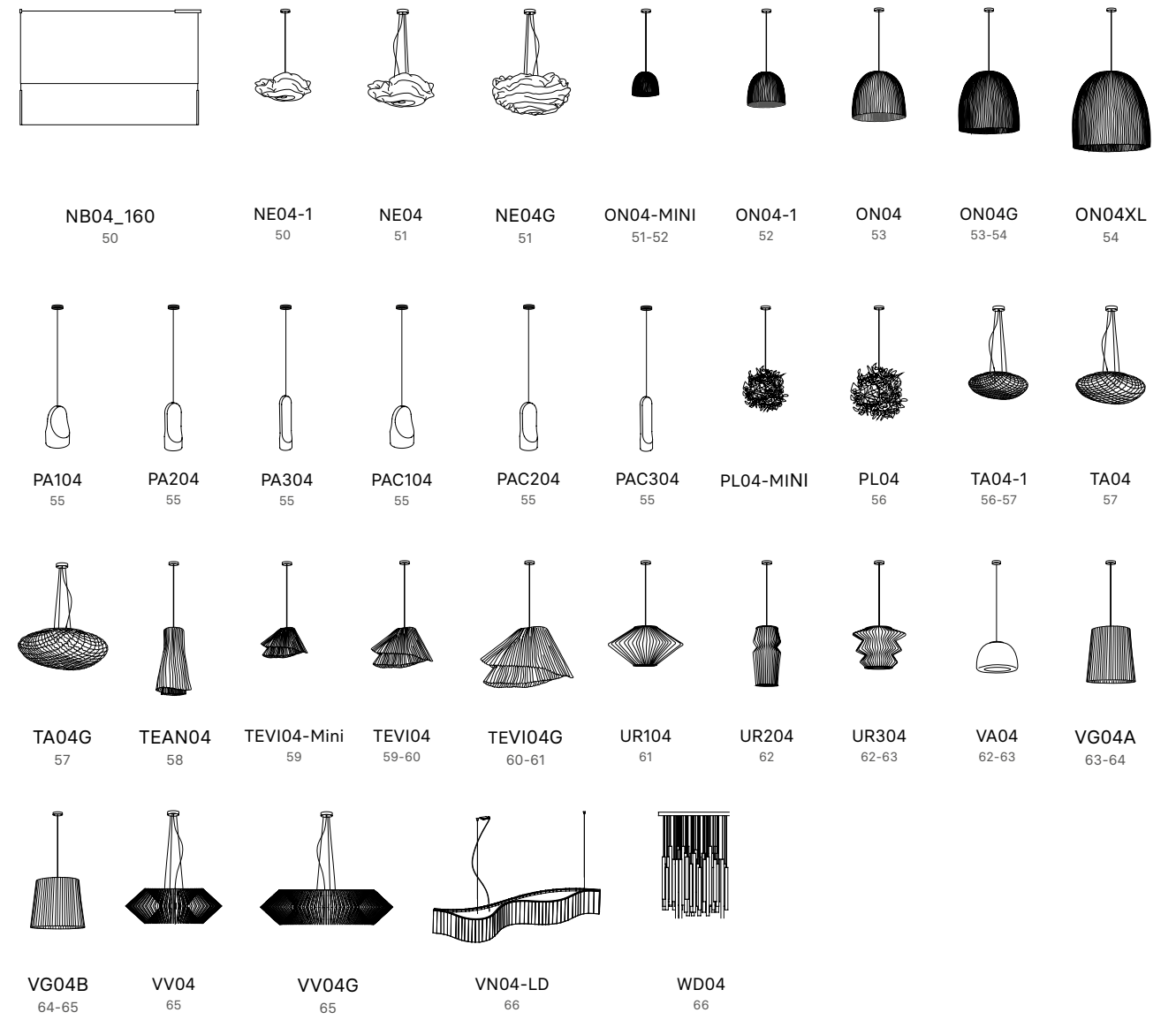
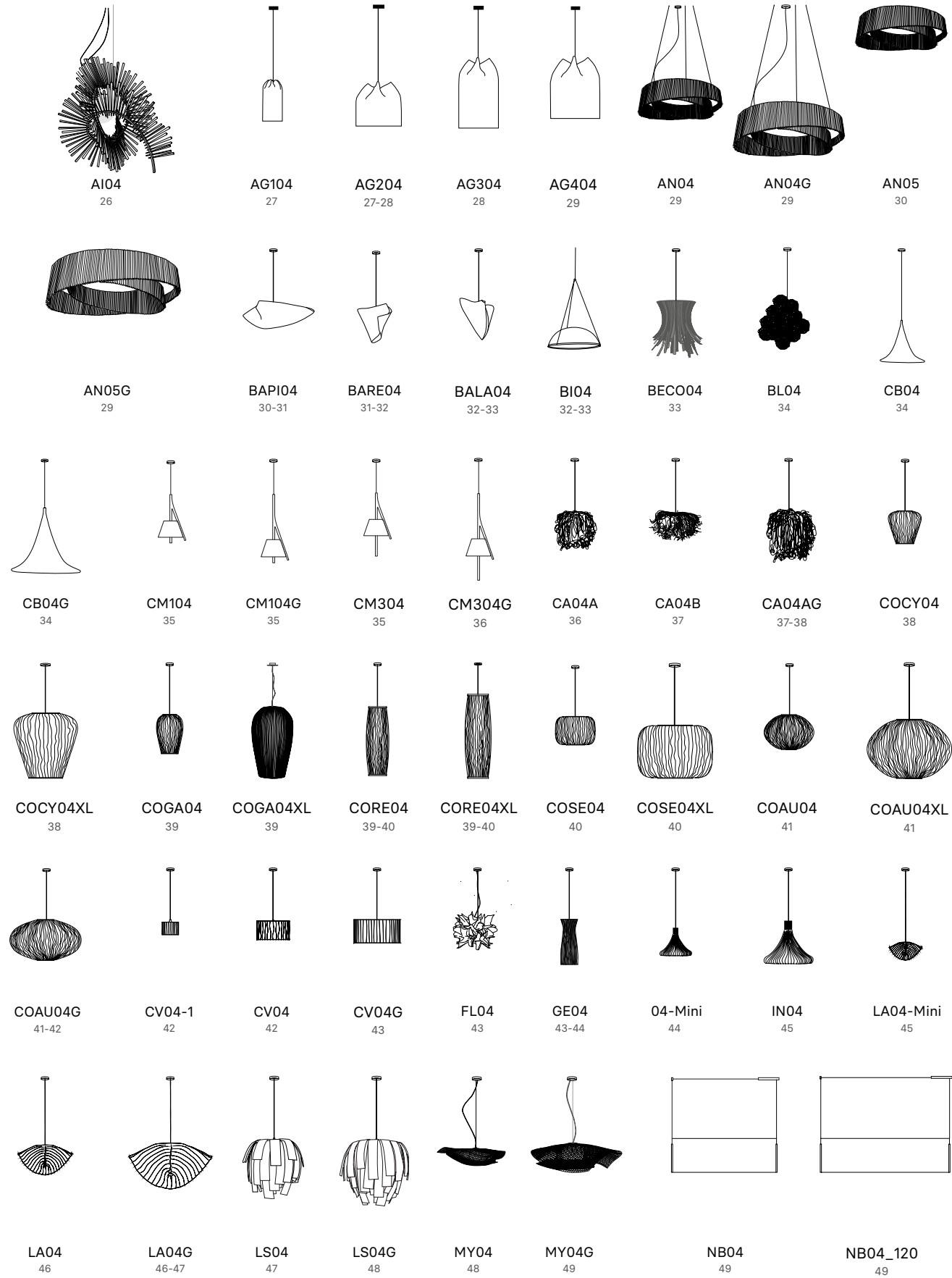

OUTDOOR LAMPS | LÁMPARAS DE EXTERIOR

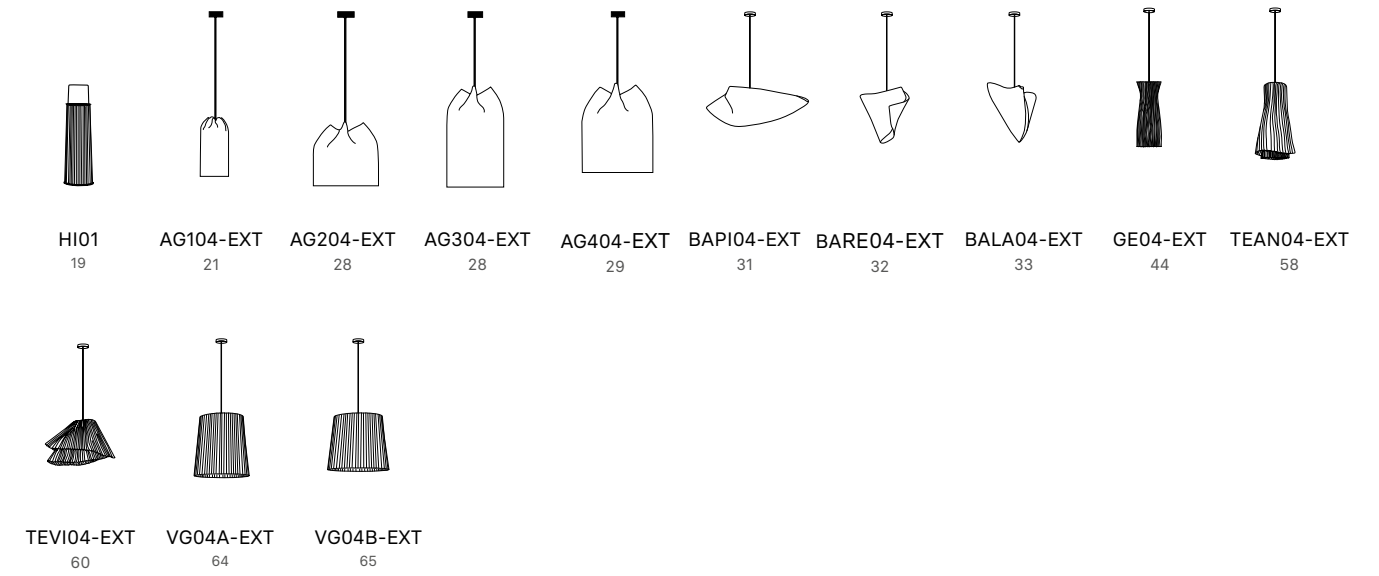

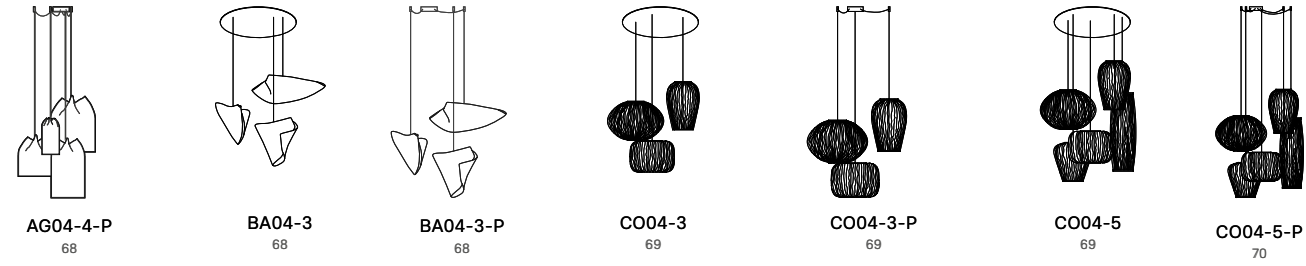

AG04-4-P 68 BA04-3 68 BA04-3-P 68 CO04-3 69 CO04-3-P 69 CO04-5 69 CO04-5-P 70

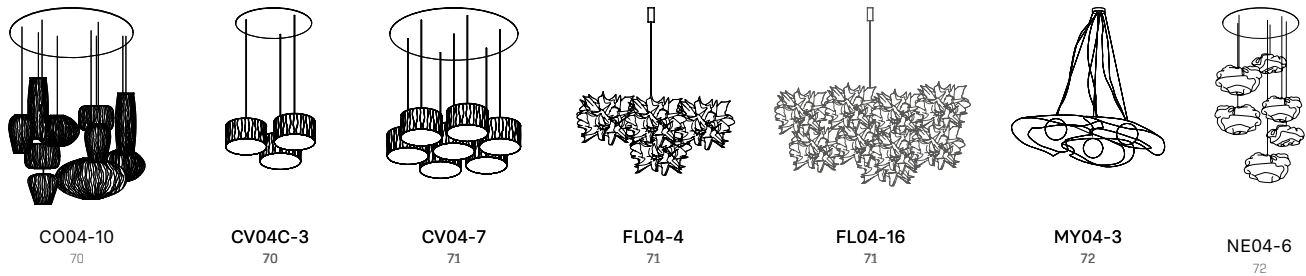

CO04-10 70 CV04C-3 70 CV04-7 71 FL04-4 71 FL04-16 71 MY04-3 72 NE04-6 72

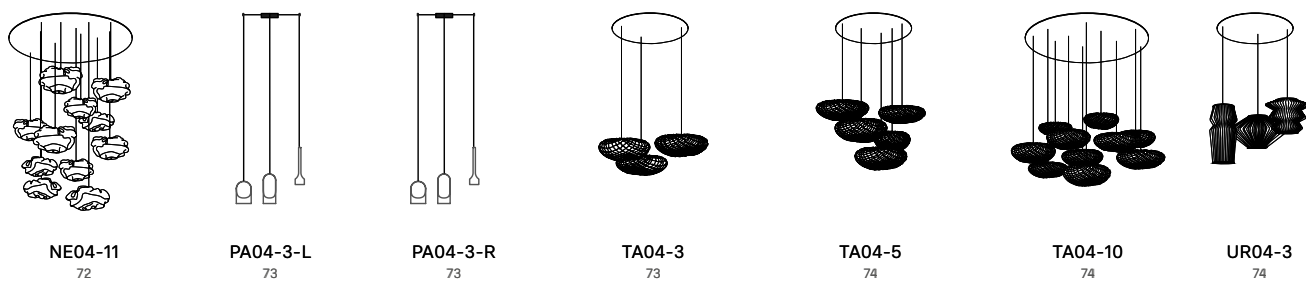

NE04-11 72 PA04-3-L 73 PA04-3-R 73 TA04-3 73 TA04-5 74 TA04-10 74 UR04-3 74

BRÉTEMA
68 - 74

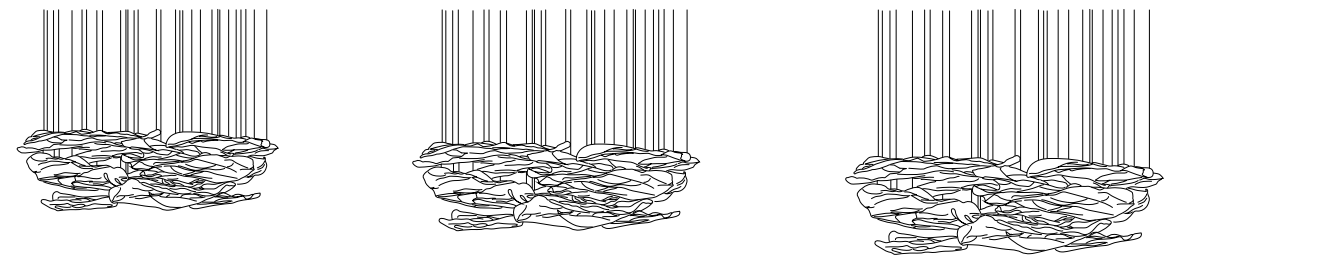

BR04S 72 BR04M 73 BR04L 73

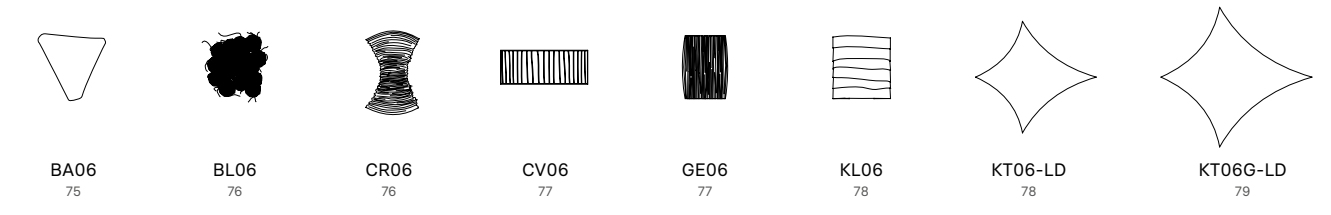

BA06 75 BL06 76 CR06 76 CV06 77 GE06 77 KL06 78 KT06-LD 78 KT06G-LD 79

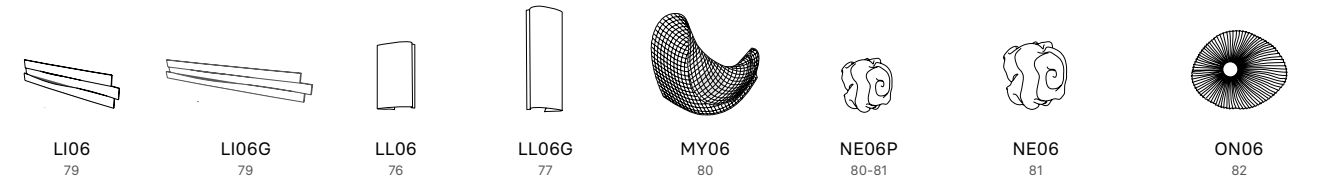

LI06 79 LI06G 79 LL06 76 LL06G 77 MY06 80 NE06P 80-81 NE06 81 ON06 82

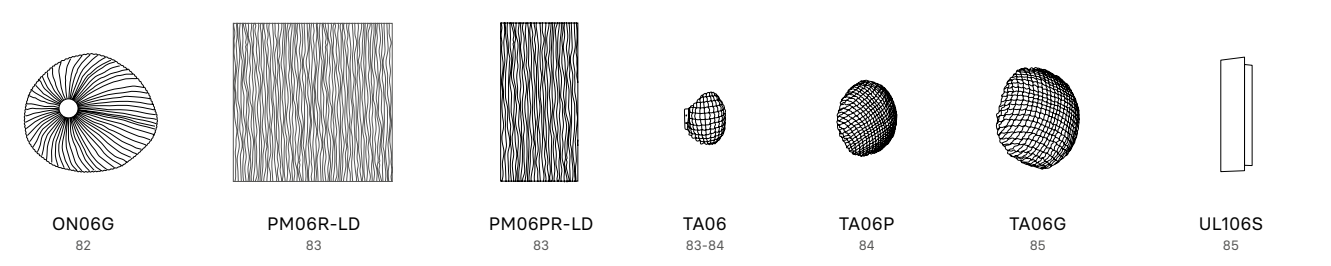

ON06G 82 PM06R-LD 83 PM06PR-LD 83 TA06 83-84 TA06P 84 TA06G 85 UL106S 85

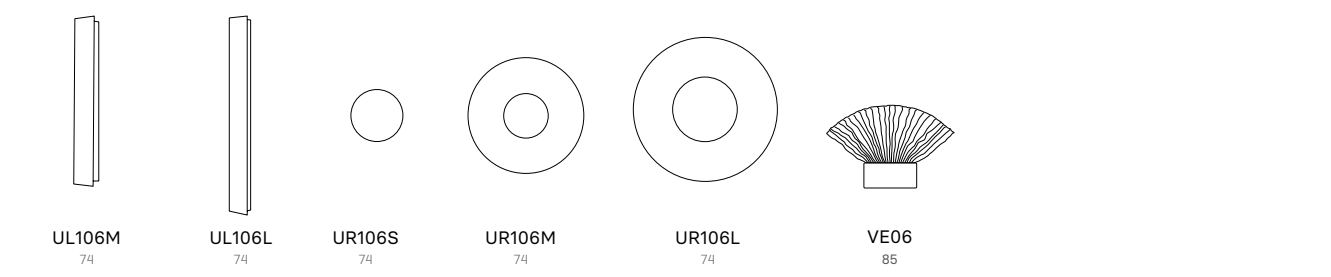

UL106M 74 UL106L 74 UR106S 74 UR106M 74 UR106L 74 VE06 85

Materials

Materialies



BL White



BE Beige

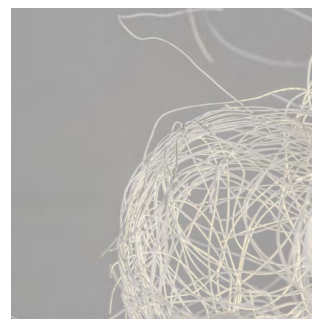

B White 2



T Taupe



N Black

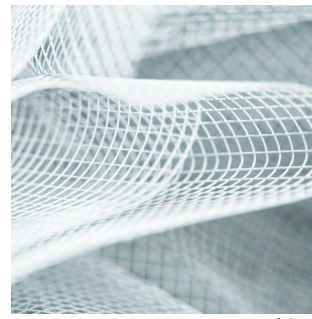

B White 3



G Grey 1



42 White

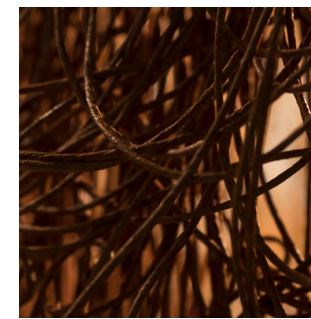

47 Brown



51 Green



43 Grey



49 Medium brown



52 Blue 4



46 Red

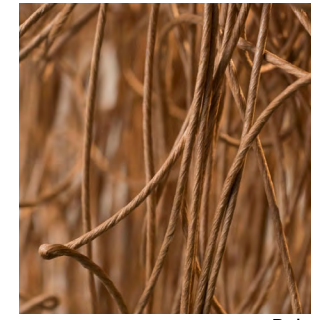

50 Beige

1. Painted stainless steel mesh Malla de acero inoxidable pintada

The stainless steel mesh is a cold industrial material that through manual techniques is converted into lamps. The physical characteristics of these materials allows through methods developed by our team, they can be folded, molded and cut resulting in creative freedom designs. The paint finish adds to this resistant and compact material a greater durability and facilitates its maintenance and cleaning.

Colors & codes: White (BL), beige (BE), grey (G), taupe (T), Black (N).
NCS / RAL Code: White (RAL 9003), beige (S 3020-Y30R), grey (S 2500-N), taupe (S 3005-Y80R), black (RAL 9004).
Collections: Africa, Agasallo, Anel, Baleira, Ballet, Blossom, Brétema, Coral, Cors, Gea, Hipatia, Inn, Kala, Kite, Lea, Lisa Luisa, Nebra, Nevo, Onn, Planum, Tati, Tempo, Umbra, Ura, Virginia, Venus.

Clara and Mytilus only available in white. Cambo only available in black or white.

La malla de acero inoxidable es un material frío de carácter industrial que a través de técnicas manuales se convierte en lámparas. Las características físicas de este material permite que a través de métodos desarrollados por nuestro equipo, se pueda plegar, moldear y cortar consiguiendo libertad creativa en los diseños. El acabado de pintura suma a este material resistente y compacto una mayor durabilidad y facilita su mantenimiento y limpieza.

Colores y códigos: Blanco (BL), beige (BE), gris (G), topo (T), negro (N).
Código NCS / RAL: Blanco RAL 9003, beige (S 3020-Y30R), gris (S 2500-N), topo (S 3005-Y80R), negro (RAL 9004).
Colecciones: Africa, Agasallo, Anel, Baleira, Ballet, Blossom, Brétema, Coral, Cors, Gea, Hipatia, Inn, Kala, Kite, Lea, Lisa, Luisa, Nebra, Nevo, Onn, Planum, Tati, Tempo, Umbra, Ura, Virginia, Venus.

Clara y Mytilus solo disponibles en blanco. Cambo solo disponible en negro o blanco.

2 Painted stainless steel thread Hilo de acero Inoxidable

The stainless steel thread interlaced and embroidered on itself, creates random, light, seemingly fragile volumes, but durable thanks to the sturdiness that paint finish brings.

Colors & codes: White (B).
Collections: Blum, Pili.

3 Galvanized steel mesh Malla de acero galvanizado

The application of galvanized steel mesh is another example of a different use of the material. The malleability of this material and its hollow light allows it, through painting processes, to become a material with a delicate appearance but of high quality and durability.

Color & code: White (B).
Collection: Fluo.

El hilo de acero inoxidable entrelazado y embrollado sobre sí mismo, crea volúmenes aleatorios, ligeros, aparentemente frágiles, pero resistentes gracias a la dureza que le aporta la pintura.

Colores y códigos: Blanco (B).
Colecciones: Blum, Pili.

La utilización de la malla de acero galvanizado es otro ejemplo de descontextualización de un material. La maleabilidad de este material y su hueco de luz permite que, a través de procesos de pintado, se convierta en un material con apariencia delicada pero de alta calidad y durabilidad.

Color y código: Blanco (B).
Colección: Fluo.

4 Cellulose cord Cordón de celulosa

The pressed cellulose cord is a pleasant texture material and has a wide range of colors. This medium flammability component is obtained from pressed cellulose and is molded using its own techniques. Due to its physical characteristics it is not recommended to wet the material for cleaning.

Colors & codes: White (42), grey (43), red (46), brown (47), medium brown (49), beige (50), green (51), blue (52).
Collection: Caos.
Arc only available in white.

El cordón de celulosa prensada es un material de agradable textura y que presenta una amplia gama de colores. Este componente de flammabilidad media se obtiene de celulosa prensada y a través de técnicas propias, se moldea. Debido a sus características físicas no se recomienda mojar el material para su limpieza.

Colores y códigos: Blanco (42), gris (43), rojo (46), marrón (47), amarillo oro (48), marrón medio (49), beige (50), verde (51), azul (52).
Colección: Caos.
Arc solo disponible en blanco.



02 White

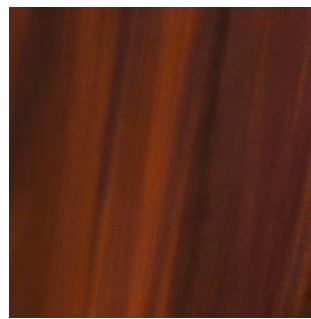

90 Brown



B White



87 Sand

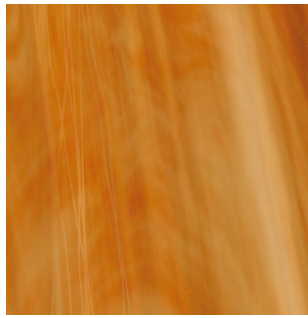

89 Dark Amber

5 Glass Vidrio

Our semi-handmade glass presents irregular watermarks that gives personality to this material. This opalescent glass comes in a wide range of bright colors.

Colors & codes:
White (02), sand (87), dark amber (89), brown (90), beige (95).
El color beige (95) solo está disponible para la combinación con marrón (90) en la colección Vento.
Collections: Curvas, Vento.

El carácter semiartesanal de nuestro vidrio presenta irregularidades en forma de aguas que dota de personalidad este material. Este vidrio opalescente se presenta en una amplia gama de colores brillantes.

Colores y códigos:
Blanco (02), arena (87), ámbar oscuro (89), marrón (90), beige (95).
The beige color (95) is only available in combination with brown (90) for the Vento collection.
Colecciones: Curvas, Vento.

6 Beech wood Haya

Beech wood is hard and characteristic for its clear and natural shades. This material is easy to work with and the varnishing makes it a very durable and easy to maintain material.

Collection: Cambo.

La madera de haya es dura y característica por sus tonalidades claras y naturales. Este material es fácil de trabajar y el barnizado lo convierte en un material muy duradero y de fácil mantenimiento.

Colección: Cambo.



B White

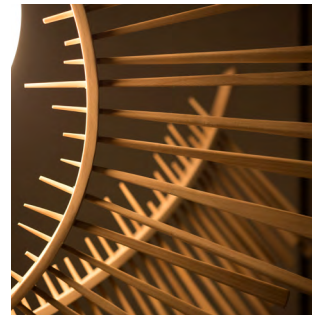

B White

7 Birch wood Abedul

A material of high durability and easy maintenance. The birch wood is characterized by its light color and low contrast, allowing easy manual processing. The light that escapes between the wooden slats turns this material into a warm and elegant wood.

Collection: Woods.

8 Ash wood Fresno

Ash wood is polyvalent and especially flexible. Its resistance make it a high quality material that, through manual processes, allows curved and durable finishes.

Collection: Aimei.

6

7

8

Un material de alta durabilidad y fácil mantenimiento. La madera de abedul caracterizada por su color claro y su bajo contraste, permite un fácil procesamiento manual. La luz que escapa entre los listones de madera convierte este material en una madera cálida y elegante.

Colección: Woods.

El fresno es una madera polivalente y especialmente flexible. Su resistencia lo convierte en un material de alta calidad que, a través de procesos manuales, permite acabados curvos y duraderos.

Colección: Aimei.



42 White

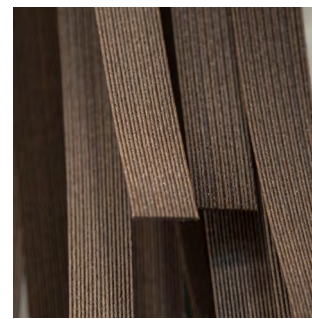

47 Brown

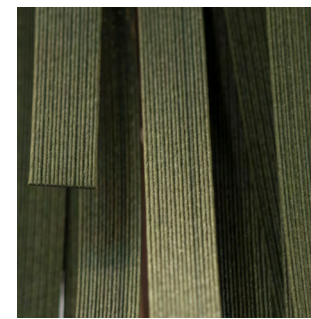

51 Green



43 Grey

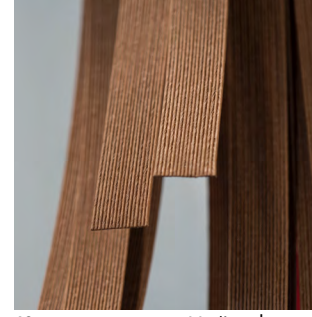

49 Medium brown



52 Blue



46 Red

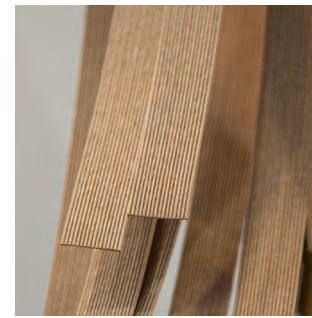

50 Beige

9 Cellulose cord Cordón de celulosa

The pressed cellulose cord is a pleasant texture material and has a wide range of colors. This medium flammability component is obtained from pressed cellulose and is molded using its own techniques. Due to its physical characteristics it is not recommended to wet the material for cleaning.

Colors & codes: White (42), grey (43), red (46), brown (47), medium brown (49), beige (50), green (51), blue (52).
Collection: Caos.
Arc only available in white.

El cordón de celulosa prensada es un material de agradable textura y que presenta una amplia gama de colores. Este componente de flammabilidad media se obtiene de celulosa prensada y a través de técnicas propias, se moldea. Debido a sus características físicas no se recomienda mojar el material para su limpieza.

Colores y códigos: Blanco (42), gris (43), rojo (46), marrón (47), amarillo oro (48), marrón medio (49), beige (50), verde (51), azul (52).
Colección: Caos.
Arc solo disponible en blanco.

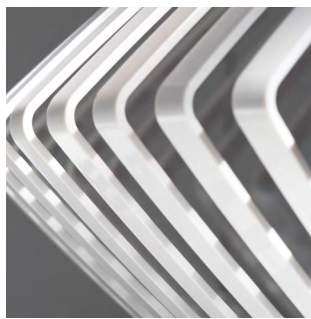

B White

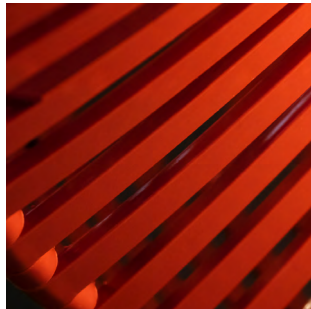

TE Terracotta



N Black

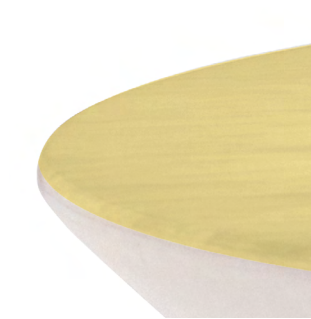

19 Yellow



25 White



B White

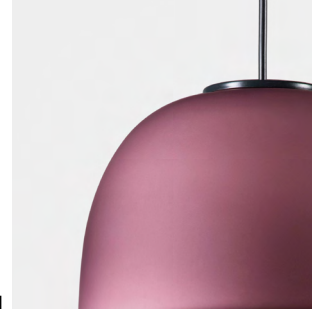

11 AM Amethyst

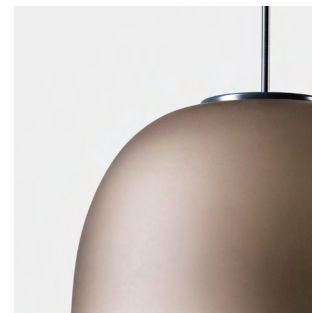

G Grey



CM Cream

10 Polycarbonate Policarbonato

Through plastic injection technology, this material is consistently made and is available in two colors. The personalized shape of each piece allows the realization of luminaires of large dimensions and easy maintenance

Colors & codes:
White (B), black (N), terracotta (TE).
Collection: V.

Mediante la tecnología de inyección de plástico, se elabora este material consistente y disponible en dos colores. La rigidez y forma personalizada de cada pieza permite la realización de luminarias de grandes dimensiones y de fácil mantenimiento.

Colores:
Blanco (B), negro (N), terracota (TE).
Colección: V.

11 Hand-crafted glass Vidrio artesanal

Our hand-crafted glass is a material that is obtained through different manual techniques, including blowing and lamination. The surface finish is done manually by using very fine sand, avoiding the use of chemical agents.

Colors & codes: Yellow (19), white (25)
Collections: Era

Nuestro cristal artesanal es un material que se obtiene mediante diferentes técnicas manuales, entre ellas el soplado y el laminado. El acabado superficial está realizado manualmente mediante el uso de arena muy fina, evitando la utilización de agentes químicos.

Colores y códigos:
Amarillo (19), Blanco (25)
Colecciones: Era

12 Colored glass Soplado coloreado

The bell shape and its wave-like lower cavity define the glass body. From within, a subdued faded light emerges, revealing its volume. It creates a halo of light within, conveying lightness, as if we were holding a firefly in a glass container.

La forma de campana y su cavidad inferior con forma de ondas definen el cuerpo de cristal. Desde el interior, surge una luz atenuada, gastada, desde donde se puede apreciar su volumen y crea un halo de luz en su interior que transmite ligereza, como si tuviéramos una luciérnaga en un recipiente de cristal.



BG Beige

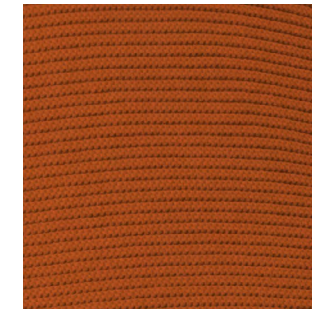

13 NA Orange

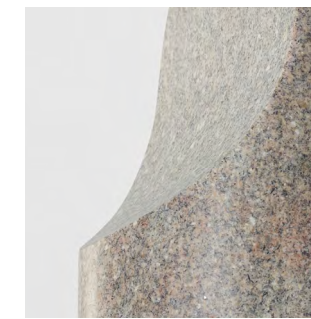

G Grey



14 N Black



B Whyte

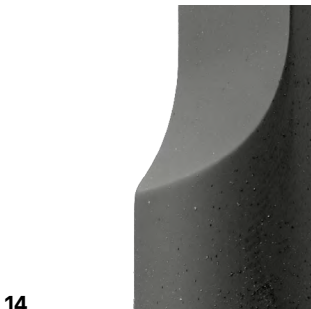

14 N Black



15 BU Burgundy

13 3D Knit Punto 3D

The 3D knit allows us to generate volumes and produce our lampshade without waste of material and without seams. It can be made with 100% recyclable materials.

Colors & codes: Beige (BG), orange (NA)
Collections: Cabana

El punto 3D permite generar volúmenes y producir nuestras pantallas sin desperdicio de material y sin costuras. Se puede fabricar con materiales 100% reciclables.

Colores y códigos: Beige (BG), naranja (NA)
Colecciones: Cabana.

15 Ceramic Cerámica

Earth and fire have been closely linked since man began developing the ability to make tools. The Parga collection expands the family by incorporating a set of ceramic pieces, seeking to preserve the modesty and simplicity of natural materials.

Collection: Parga.

La tierra y el fuego son elementos estrechamente ligados desde que el hombre comienza a desarrollar la capacidad para fabricar útiles. La colección Parga amplía la familia incorporando un conjunto de piezas cerámicas, buscando preservar la modestia y sencillez de los materiales naturales.

Collection: Parga.

14 Granite Granito

Galician granite is a natural and sustainable material that is easy to maintain. With a light greyish tone, fine-grained and with black speckles, this material used in Parga is compact and comes from discards. It is a material that is highly resistant to heat and wear.

Now, it features a black finish that adds a sophisticated and versatile dimension. The depth of the tone enhances the contrast between the texture of the granite and the softness of the light, creating a piece with a strong visual presence.

Collection: Parga.

El granito gallego es un material de origen natural y sostenible de fácil mantenimiento. De tono grisáceo claro, de grano fino y con motas negras, este material empleado en Parga es compacto y proviene de descartes. Es un material de alta resistencia al calor y al desgaste

Ahora, incorpora un acabado en negro que aporta una dimensión sofisticada y versátil. La profundidad del tono potencia el contraste entre la textura del granito y la suavidad de la luz, creando una pieza con una fuerte presencia visual.

Colección: Parga.

All lamps are labelled with an identification code and serial number. This fixture is an exclusive and authentic design of the company a-emotional light. It is entirely handmade in Spain and passes strict quality controls before its entrance into the market.

All our lamps are totally handmade. The differences found in our luminaires and in the different materials used make them unique. Small differences between lamps are not a defect, it is a value because each one is a unique object. The indicated lampshade dimensions are only approximate, never exact.

Some dimensions and/or electrical data may vary, consult your sales advisor.

Todas las lámparas salen con etiquetas que reflejan la referencia y número de serie. Esta lámpara es un diseño exclusivo y auténtico de la empresa a-emotional light. Está producida y hecha totalmente a mano en España. Pasa estrictos controles de calidad antes de su salida al mercado.

Todas nuestras lámparas están hechas a mano. Las diferencias entre ellas y en los distintos materiales empleados convierten a cada lámpara en única. Pequeñas diferencias entre lámparas de una misma referencia no son un defecto, sino un valor, cada una es un objeto único. Las dimensiones de las tulipas indicadas son sólo aproximadas y nunca exactas.

Algunas dimensiones y/o datos eléctricos pueden variar, consulte con su asesor comercial.

Technical catalogue

Catálogo técnico



















 <p>Fitting is legally approved and comply with the European Mark CE</p> <p>Luminaria homologada, cumple con la normativa CE</p>	 <p>Only for the USA, these items comply with the UL standard for luminaires under the UL file of a-emotional light</p> <p>Solo para EE.UU., estos artículos cumplen con el estándar UL para luminarias bajo el archivo UL de a-emotional light</p>	 <p>For North America, these items comply with the UL standard for luminaires under the UL file of a-emotional light</p> <p>Para América del Norte, estos artículos cumplen con el estándar UL para luminarias bajo el archivo UL de a-emotional light</p>	 <p>Product marking used for products being placed on the market in Great Britain (England, Scotland and Wales)</p> <p>Marcado de producto utilizada para los productos que se comercializan en Gran Bretaña (Inglaterra, Escocia y Gales)</p>
 <p>The luminaires made of painted stainless steel mesh can be chosen by RAL or NCS code (see conditions)</p> <p>Las luminarias realizadas en malla de acero inoxidable pintada podrán elegirse el color mediante código RAL o NCS (ver condiciones).</p>	 <p>Awarded by the International Interior Design Association (IIDA) and Hospitality Design magazine.</p> <p>Premio otorgado por International Interior Design Association (IIDA) y la revista Hospitality Design</p>	 <p>Awarded by Interior Design Magazine, New York</p> <p>Premio otorgado por la revista Interior Design de New York</p>	 <p>Awarded by the Chicago Athenaeum Museum of Architecture and Design</p> <p>Premio otorgado por el Chicago Athenaeum Museo de Arquitectura y Diseño</p>
 <p>Awarded by Industrial Design Association of the FAD (ADI-FAD), Barcelona</p> <p>Premio otorgado por la Asociación de Diseño Industrial del FAD (ADI-FAD), Barcelona</p>	 <p>Double insulation and/or reinforced insulation in every part and without ground devices</p> <p>Doble aislamiento y/o aislamiento en cada parte y sin toma de tierra</p>	 <p>Luminaire to use with tungsten halogen bulbs with own protection shield</p> <p>Luminaria diseñada para usar lámparas halógenas de volframio con pantalla de protección propia</p>	 <p>The device is not suitable for installation on normally inflammable surface</p> <p>Aparato no adaptado para la instalación en superficies normalmente inflamables</p>
 <p>Available with LED built-in technology</p> <p>Disponible con tecnología LED integrada</p>	 <p>Professional standard bidirectional regulation interface for lighting equipment control</p> <p>Interfaz profesional estándar de regulación bidireccional para control de equipos de iluminación</p>	 <p>Regulation for small installations without adding additional control wiring.</p> <p>Regulación para instalaciones pequeñas sin necesidad de añadir cableado adicional de control. PHASE CUT - 230V</p>	 <p>Regulation of luminous flux between 0 and 10V (1-100%) through an analog signal. Compatible with TRIAC (forward-phase or leading-edge), ELV (reverse-phase or trailing edge) - only at 120Vac.</p> <p>Regulación de flujo lumínico entre 0 y 10V (1-100%) a través de una señal analógica. Compatible con TRIAC (fase directa o borde de ataque), ELV (fase inversa o borde de salida).</p>
 <p>Available for outdoor IP64</p> <p>Disponible para exterior IP64</p>	 <p>With ground devices Con toma de tierra</p>	 <p>According to Americans with Disabilities Act</p> <p>De acuerdo con la ley de discapacidades de los estadounidenses</p>	

Table lamps

Lámparas de mesa

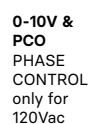
Arc

Arturo Álvarez, 2015

p. 40

MATERIAL MATERIAL	Cord Cordón
FINISHES ACABADOS	42 
CABLE	Transparent · Transparente L 200cm 78,7"
SUPPORT SOPORTE	Stainless steel Acero inoxidable

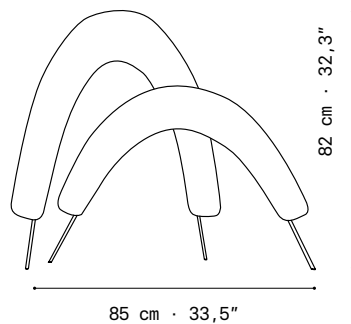

ACO2



85 cm · 33,5"

82 cm · 32,3"







Depth · Profundidad
35 cm | 13,7"

LIGHT SOURCE FUENTE DE LUZ	Built-in LED strip Tira LED integrada
230 V 50 Hz	 28 W 3000 K 2897 lm
120 V 60 Hz	 28 W 3000 K 2897 lm
NET WEIGHT PESO NETO	8 kg 17,6 lb
PACKAGING EMBALAJE	71x71x43 cm 28x28x17" 10 kg 22 lb

Agasallo Table

Héctor Serrano, 2025

p. 40

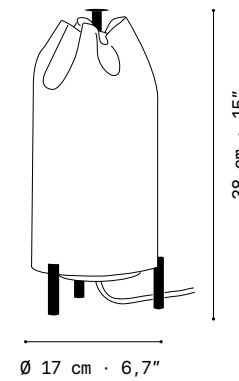

MATERIALS MATERIALES	Stainless steel mesh Malla de acero inoxidable
FINISHES ACABADOS	White · Blanco  Beige · Beige  Grey · Gris  Taupe · Topo  Black · Negro  Custom · Personalizado 
CABLE	Transparent or Black Transparente o negro L 200cm 78,7"
SUPPORT SOPORTE	Stainless steel Acero inoxidable

AGO1



38 cm · 15"

Ø 17 cm · 6,7"

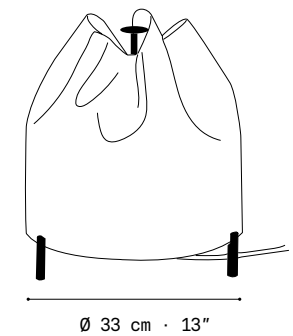

LIGHT SOURCE FUENTE DE LUZ	Recommended bulbs Bombillas recomendadas
230 V 50 Hz	 E27 LED Vintage- Max. 1x7 W
120 V 60 Hz	 E26 LED - Max. 1x7 W
NET WEIGHT PESO NETO	1,4 kg 3,1 lb
PACKAGING EMBALAJE	46x24x26 cm 18,1x9,4x10,2" 2,5 kg 5,5 lb

AGO2



38 cm · 15"

Ø 33 cm · 13"

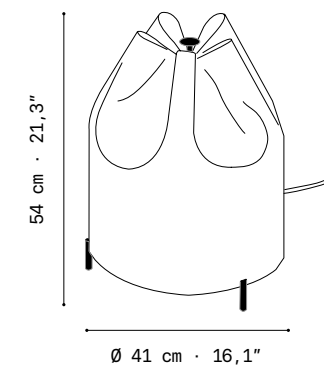

LIGHT SOURCE FUENTE DE LUZ	Recommended bulbs Bombillas recomendadas
230 V 50 Hz	 E27 LED Vintage- Max. 1x7 W
120 V 60 Hz	 E26 LED - Max. 1x7 W
NET WEIGHT PESO NETO	1,8 kg 4 lb
PACKAGING EMBALAJE	44x44x40 cm 17,3x17,3x15,7" 3 kg 6,6 lb

AGO2G



54 cm · 21,3"

Ø 41 cm · 16,1"

LIGHT SOURCE FUENTE DE LUZ	Recommended bulbs Bombillas recomendadas
230 V 50 Hz	 E27 LED Vintage- Max. 1x7 W
120 V 60 Hz	 E26 LED - Max. 1x7 W
NET WEIGHT PESO NETO	2,4 kg 5,3 lb
PACKAGING EMBALAJE	47x47x63 cm 18,5x18,5x24,8" 4,3 kg 9,5 lb

Bety Eco

Arturo Álvarez, 2009

p. 40

MATERIAL
MATERIAL

Pressed Cellulose
Celulosa prensada

FINISHES
ACABADOS

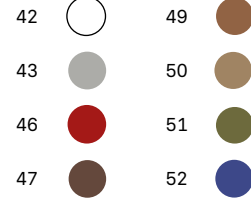

CABLE
Transparent · Transparente
L 200cm | 78,7"

SUPPORT
SOPORTE

Stainless Steel
Acero inoxidable

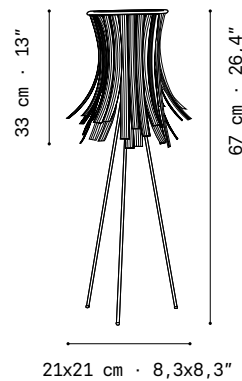

BEC001



LIGHT SOURCE
FUENTE DE LUZ

230 V | 50 Hz

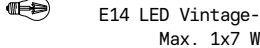

120 V | 60 Hz

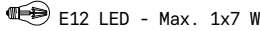

NET WEIGHT
PESO NETO

1,5 kg | 3,3 lb

PACKAGING
EMBALAJE

65x32x23 cm | 25,6x12,6x9,1"
3 kg | 6,6 lb

Blossom

Teresa Sapey + Partners, 2023

p. 40

MATERIAL
MATERIAL

Painted stainless steel
Acero inoxidable pintado

FINISHES
ACABADOS

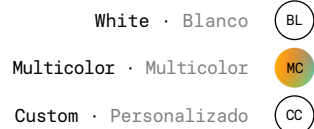

CABLE
White · Blanco
L 200cm | 78,7"

SUPPORT
SOPORTE

Stainless Steel
Acero inoxidable

DIFFUSER
DIFUSOR

Included
Incluido

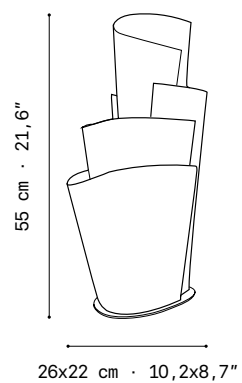

BS02



LIGHT SOURCE
FUENTE DE LUZ

230 V | 50 Hz

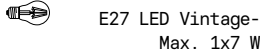

120 V | 60 Hz

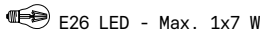

NET WEIGHT
PESO NETO

2,9 kg | 6,6 lb

PACKAGING
EMBALAJE

32x23x65 cm | 12,6x9x25,6"
4 kg | 8,8 lb

Cambo

Cenlitos, 2022

p. 40

MATERIALS
MATERIALES

Painted steel
Acero pintado

Painted aluminum
Aluminio pintado

Painted stainless steel
Acero inoxidable pintado

Beech wood
Madera de haya

FINISHES
ACABADOS

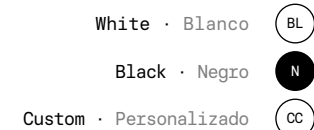

CABLE
Black or White · Blanco o negro
L 200cm | 78,7"

SUPPORT
SOPORTE

Painted steel
Acero pintado

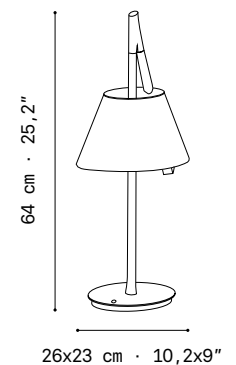

CM01



LIGHT SOURCE
FUENTE DE LUZ

230 V | 50 Hz

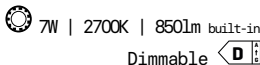

100-277 V | 60 Hz



NET WEIGHT
PESO NETO

1,9 kg | 4,3 lb

PACKAGING
EMBALAJE

84x38x28 cm | 33x14,9x11"
4,6 kg | 10,1 lb

Clara

Arturo Álvarez, 2021

p. 40

MATERIAL
MATERIAL

Painted stainless steel
Acero inoxidable pintado

FINISHES
ACABADOS

White · Blanco (BL)

CABLE
Transparent · Transparente
L 200cm | 78,7"

SUPPORT
SOPORTE

Stainless steel
Acero inoxidable

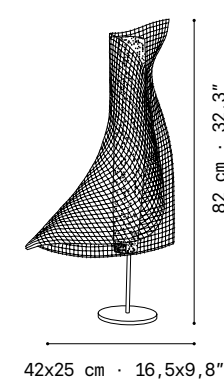

CLO2



LIGHT SOURCE
FUENTE DE LUZ

230 V | 50 Hz

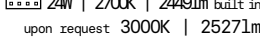

100-277 V | 60 Hz

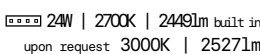

NET WEIGHT
PESO NETO

4,7 kg | 10,4 lb

PACKAGING
EMBALAJE

44x44x88 cm | 17,3x17,3x34,6"
10 kg | 22 lb

Curvas

Arturo Álvarez, 2004

p. 40

MATERIAL
MATERIAL

Glass
Vidrio

FINISHES
ACABADOS

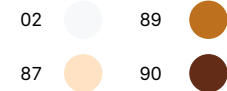

CABLE
Transparent or Black
Transparente o negro
L 200cm | 78,7"

SUPPORT
SOPORTE

Painted steel | Stainless steel
Acero pintado | Acero inoxidable

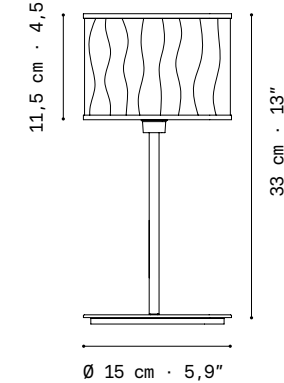

CV01



LIGHT SOURCE
FUENTE DE LUZ

230 V | 50 Hz

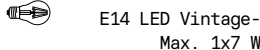

120 V | 60 Hz

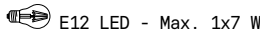

NET WEIGHT
PESO NETO

1,9 kg | 4,2 lb

PACKAGING
EMBALAJE

46x24x26 cm | 17,7x9,4x10,2"
2,6 kg | 5,7 lb

Era

Isaac Piñeiro, 2023

MATERIAL
MATERIAL

Hand-crafted glass
Vidrio artesanal

FINISHES
ACABADOS

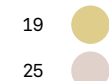

CABLE
Black · Negro
L 120cm | 47,2"

SUPPORT
SOPORTE

Steel painted in matt black
Acero pintado en negro mate

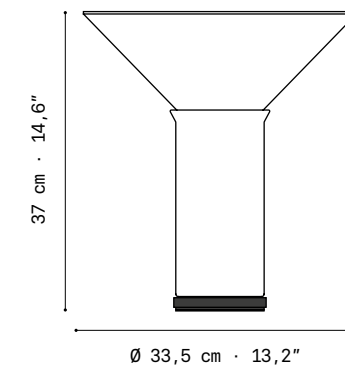

ERO1



LIGHT SOURCE
FUENTE DE LUZ

230 V | 50 Hz

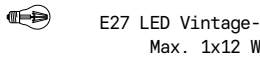

120 V | 60 Hz

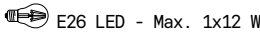

NET WEIGHT
PESO NETO

5 kg | 9,2 lb

PACKAGING
EMBALAJE

50x50x50 cm | 20,7x20,7x20,9"
7 kg | 15,4 lb

Hipatia

a-emotional light design team, 2021 p. 40

MATERIAL Painted stainless steel
MATERIAL Acero inoxidable pintado

FINISHES White · Blanco (BL)
ACABADOS

Custom · Personalizado (CC)

CABLE Wireless · Inalámbrico
USB cable + charger
Cable USB + cargador

SUPPORT Painted steel | Stainless steel
SOPORTE Acero pintado | Acero inoxidable

Portable · Portátil
Includes remote control
(reach 10m | 39,4")
Incluye mando a distancia
(alcance 10m | 39,4")
Autonomy · Autonomía

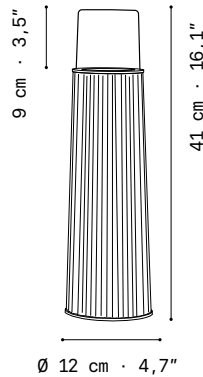

LIGHT SOURCE Light source built in
FUENTE DE LUZ Fuente de luz incluida

230 V | 50 Hz
3000K | 247lm built-in
Rechargeable battery
5V - 2A - 5000mAh

120 V | 60 Hz
3000K | 247lm built-in
Rechargeable battery
5V - 2A - 5000mAh

NET WEIGHT 1 kg | 2,2 lb
PESO NETO

PACKAGING 19x51x27 cm | 7,4x20x10,6"
EMBALAJE 1,4 kg | 3,1 lb

Functions · Funciones
ON/OFF/DIMMING
In charge · En carga 8/10



Nevo

Arturo Álvarez, 2007 p. 40

MATERIALS Painted stainless steel
MATERIALES Acero inoxidable pintado

Steel gloss nickel-plated
Acero niquel-satinado

FINISHES White · Blanco (BL)
ACABADOS

Beige · Beige (BE)

Grey · Gris (G)

Taupe · Topo (T)

Custom · Personalizado (CC)

CABLE Transparent or Black
Transparente o negro
L 120cm | 47,2"
NEO2 L 200cm | 78,7"

SUPPORT Painted steel | Stainless steel
SOPORTE Acero pintado | Acero inoxidable

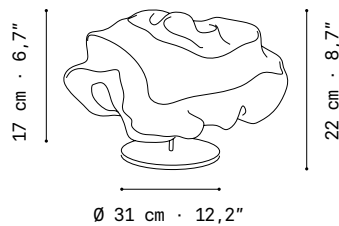

LIGHT SOURCE Recommended bulbs
FUENTE DE LUZ Bombillas recomendadas

230 V | 50 Hz E14 LED Vintage-
Max. 2x7 W

120 V | 60 Hz E12 LED - Max. 2x7 W

NET WEIGHT 1,6 kg | 3,5 lb
PESO NETO

PACKAGING 36x36x31 cm | 14,2x14,2x12,2"
EMBALAJE 2,5 kg | 5,5 lb



NEO1

NEO2

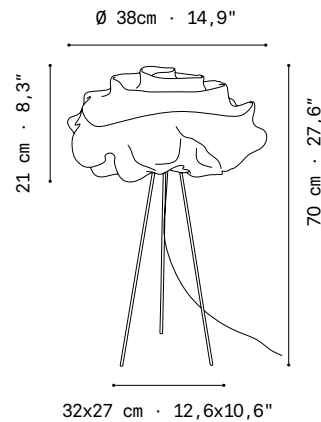

LIGHT SOURCE Recommended bulbs
FUENTE DE LUZ Bombillas recomendadas

230 V | 50 Hz E14 LED Vintage-
Max. 2x7 W

120 V | 60 Hz E12 LED - Max. 2x7 W

NET WEIGHT 2 kg | 4,4 lb
PESO NETO

PACKAGING 60x60x33 cm | 23,6x23,6x13"
EMBALAJE 4 kg | 8,8 lb



Onn

Arturo Álvarez, 2017 p. 40

MATERIALS Painted stainless steel
MATERIALES Acero inoxidable pintado
Steel gloss nickel-plated
Acero niquel-satinado

FINISHES White · Blanco (BL)
ACABADOS

Beige · Beige (BE)

Grey · Gris (G)

Taupe · Topo (T)

Black · Negro (N)

Custom · Personalizado (CC)

CABLE Transparent or Black
Transparente o negro
L 200cm | 78,7"

SUPPORT Stainless steel
SOPORTE Acero inoxidable

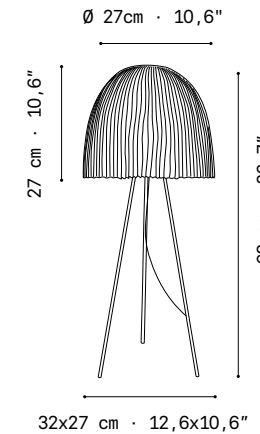

LIGHT SOURCE Recommended bulbs
FUENTE DE LUZ Bombillas recomendadas

230 V | 50 Hz E14 LED Vintage-
Max. 2x7 W

120 V | 60 Hz E12 LED - Max. 2x7 W

NET WEIGHT 3,5 kg | 7,7 lb
PESO NETO

PACKAGING 60x60x33 cm | 23,6x23,6x13"
EMBALAJE 4,5 kg | 9,9 lb

Tati

Arturo Álvarez, 2011 p. 40

MATERIALS Painted stainless steel
MATERIALES Acero inoxidable pintado

Steel gloss nickel-plated
Acero niquel-satinado

FINISHES White · Blanco (BL)
ACABADOS

Beige · Beige (BE)

Grey · Gris (G)

Taupe · Topo (T)

Custom · Personalizado (CC)

CABLE Transparent or Black
Transparente o negro
L 200cm | 78,7"

SUPPORT Stainless steel
SOPORTE Acero inoxidable

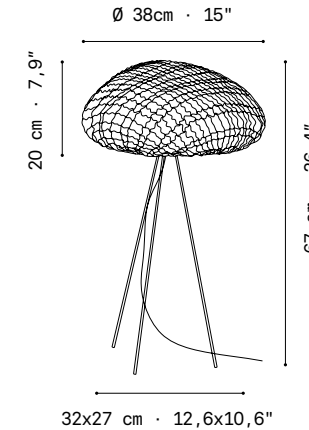

LIGHT SOURCE Recommended bulbs
FUENTE DE LUZ Bombillas recomendadas

230 V | 50 Hz E14 LED Vintage-
Max. 2x7 W

120 V | 60 Hz E12 LED - Max. 2x7 W

NET WEIGHT 1,6 kg | 3,5 lb
PESO NETO

PACKAGING 60x60x33 cm | 23,6x23,6x13"
EMBALAJE 4 kg | 8,8 lb

Ura

Arturo Álvarez, 2017

MATERIALS Painted stainless steel
MATERIALES Acero inoxidable pintado

FINISHES White · Blanco (BL)
ACABADOS

Beige · Beige (BE)

Grey · Gris (G)

Taupe · Topo (T)

Black · Negro (N)

Custom · Personalizado (CC)

CABLE Transparent or Black
Transparente o negro
L 120cm | 47,2"

SUPPORT Stainless steel
SOPORTE Acero inoxidable

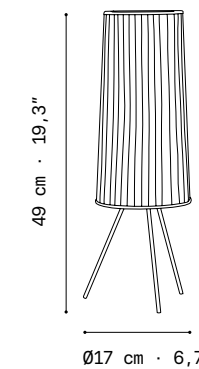

LIGHT SOURCE Recommended bulbs
FUENTE DE LUZ Bombillas recomendadas

230 V | 50 Hz E27 LED Vintage-
Max. 1x12 W

120 V | 60 Hz E26 LED - Max. 1x12 W

NET WEIGHT 1 kg | 2,2 lb
PESO NETO

PACKAGING 65x32x23 cm | 25,5x12,6x9,1"
EMBALAJE 1,8 kg | 3,9 lb

ONO2



TAO2



URO1



Floor lamps

Lámparas de pie

Africa

Arturo Álvarez, 2014 p. 40

MATERIALS Painted stainless steel
MATERIALES Acero inoxidable pintado

FINISHES White · Blanco (BL)
ACABADOS

Beige · Beige (BE)

Grey · Gris (G)

Taupe · Topo (T)

Custom · Personalizado (CC)

CABLE Transparent or Black
Transparente o negro
L 250 cm | 98,4"

SUPPORT Painted steel | Stainless steel
SOPORTE Acero pintado | Acero inoxidable

Agasallo Floor

Héctor Serrano, 2025 p. 40

MATERIALS Stainless steel mesh
MATERIALES Malla de acero inoxidable

FINISHES White · Blanco (BL)
ACABADOS

Beige · Beige (BE)

Grey · Gris (G)

Taupe · Topo (T)

Black · Negro (N)

Custom · Personalizado (CC)

CABLE Transparent or Black
Transparente o negro

SUPPORT Stainless steel
SOPORTE Acero inoxidable

DIFFUSER Included
DIFUSOR Incluido

AF03

Ø 143 cm · 56,3"

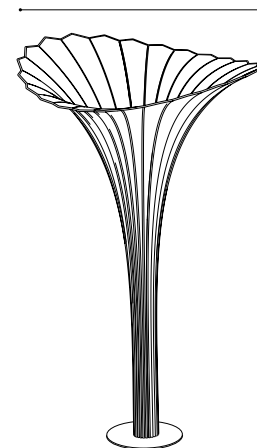

220 cm · 86,6"



LIGHT SOURCE Recommended bulbs
FUENTE DE LUZ Bombillas recomendadas

230 V | 50 Hz E14 LED Vintage-
Max. 3x12 W

120 V | 60 Hz E12 LED - Max. 3x12 W

NET WEIGHT 60 kg | 132,7 lb
PESO NETO

PACKAGING 154x153x242 cm | 60,6x60,2x95,7"
EMBALAJE 272 kg | 600 lb

AG03

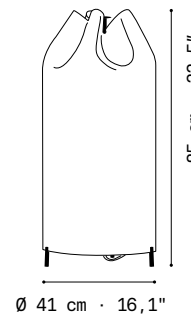

85 cm · 33,5"

Ø 41 cm · 16,1"



LIGHT SOURCE Recommended bulbs
FUENTE DE LUZ Bombillas recomendadas

230 V | 50 Hz E27 LED Vintage-
Max. 1x7 W

120 V | 60 Hz E26 LED - Max. 1x7 W

NET WEIGHT 3,4 kg | 7,5 lb
PESO NETO

PACKAGING 46x46x90 cm | 18,1x18,1x35,4"
EMBALAJE 6 kg | 13,2 lb

Arc

Arturo Álvarez, 2014 p. 40

MATERIALS Stainless steel mesh
MATERIALES Malla de acero inoxidable

FINISHES 42 (BL)
ACABADOS

CABLE Transparent · Transparente
L 300 cm | 318,1"

SUPPORT Painted steel
SOPORTE Acero pintado

ACO3

LED

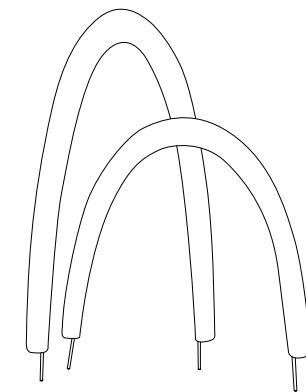

220 cm · 86,6"

160 cm · 62,9"

LIGHT SOURCE Recommended bulbs
FUENTE DE LUZ Bombillas recomendadas

230 V | 50 Hz 85 W | 3000 K | 6850 lm
built-in

100-240 V | 60 Hz 85 W | 3000 K | 6850 lm
built-in

NET WEIGHT 15 kg | 33,1 lb
PESO NETO

PACKAGING 54x160x210 cm | 21,3x63x82,7"
EMBALAJE 167 kg | 368 lb

Bety Eco

Arturo Álvarez, 2009 p. 40

MATERIAL Pressed Cellulose
MATERIAL Celulosa prensada

FINISHES 42 (BL) 49 (BR)
ACABADOS

43 (GR) 50 (BE)

46 (RD) 51 (GR)

47 (BR) 52 (BL)

CABLE Transparent or Black
Transparente o negro
L 250 cm | 98,4"

SUPPORT Stainless steel
SOPORTE Acero inoxidable

BECO03



Ø 42cm · 16,5"

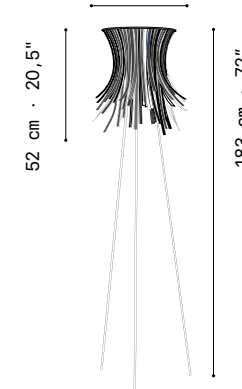

52 cm · 20,5"

183 cm · 72"

50x50 cm · 19,7x19,7"

LIGHT SOURCE Recommended bulbs
FUENTE DE LUZ Bombillas recomendadas

230 V | 50 Hz E27 LED Vintage-
Max. 1x12 W

120 V | 60 Hz E26 LED - Max. 1x12 W

NET WEIGHT 5,5 kg | 12,1 lb
PESO NETO

PACKAGING 180x11x11 cm | 70,9x4,3x4,3"
EMBALAJE 47x47x63 cm | 18,5x18,5x24,8"
8 kg | 17,6 lb

Clara

Arturo Álvarez, 2021 p. 40

MATERIALS Stainless steel mesh
MATERIALES Malla de acero inoxidable

FINISHES White · Blanco (BL)
ACABADOS

CABLE Transparent · Transparente
L 250 cm | 98,4"

SUPPORT Painted steel | Stainless steel
SOPORTE Acero pintado | Acero inoxidable

CLO3

LED



35x30 cm · 13,8x11,8"

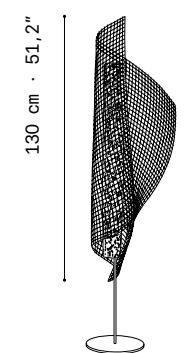

130 cm · 51,2"

160 cm · 63"

LIGHT SOURCE Recommended bulbs
FUENTE DE LUZ Bombillas recomendadas

230 V | 50 Hz 35W | 2700K | 3367 built in
upon request 3000K | 3474lm

100-277 V | 60 Hz 35W | 2700K | 339m built in
upon request 3000K | 3474





NET WEIGHT 10 kg | 22 lb
PESO NETO

PACKAGING 174x45x31 cm | 68,5x17,7x12,2"
EMBALAJE 15 kg | 33,1 lb

Curvas



Arturo Álvarez, 2004

p. 40

MATERIAL MATERIAL	Glass Vidrio
FINISHES ACABADOS	02  89  87  90 
CABLE	Transparent or Black Transparente o negro L 250cm 98,4"
SUPPORT SOPORTE	Painted steel Stainless steel Acero pintado Acero inoxidable
DIFFUSER DIFUSOR	Top diffuser Difusor superior

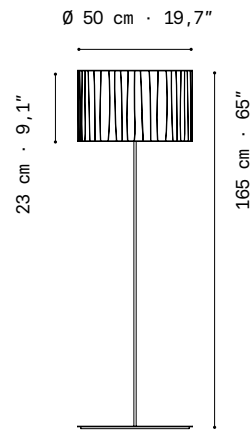
CV03G







LIGHT SOURCE FUENTE DE LUZ	Recommended bulbs Bombillas recomendadas ONLY DIMMABLE LED BULBS
230 V 50 Hz	 E27 LED Vintage- Max. 4x12 W Dimmable Regulable
120 V 60 Hz	 E26 LED - Max. 4x12 W Dimmable Regulable
NET WEIGHT PESO NETO	12,5 kg 25,6 lb
PACKAGING EMBALAJE	185x45x25 cm 72,8x17,7x9,8" 47x47x63 cm 18,5x18,5x24,8" 15kg 33,1lb

Gea



Arturo Álvarez, 2007

p. 40

MATERIALS MATERIALES	Painted stainless steel Acero inoxidable pintado
FINISHES ACABADOS	White · Blanco  Beige · Beige  Grey · Gris  Taupe · Topo  Custom · Personalizado 
CABLE	Transparent or Black Transparente o negro L 350cm 137,8"

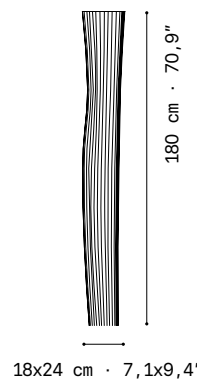
GE03



LIGHT SOURCE FUENTE DE LUZ	Recommended bulbs Bombillas recomendadas ONLY DIMMABLE LED BULBS
230 V 50 Hz	 E27 LED Vintage- Max. 5x12 W Dimmable Regulable
120 V 60 Hz	 E26 LED - Max. 5x12 W Dimmable Regulable
NET WEIGHT PESO NETO	14,5 kg 32 lb
PACKAGING EMBALAJE	188x44x26 cm 74x17,2x10,23" 19kg 41,9lb

Ura



Arturo Álvarez, 2017

p. 40

MATERIALS MATERIALES	Painted stainless steel Acero inoxidable pintado
FINISHES ACABADOS	White · Blanco  Beige · Beige  Grey · Gris  Taupe · Topo  Black · Negro  Custom · Personalizado 
CABLE	Transparent · Transparente L 250cm 98,4"
SUPPORT SOPORTE	Stainless steel Acero inoxidable

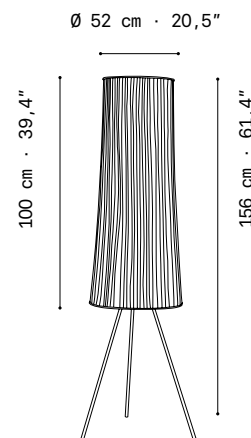
UR03



LIGHT SOURCE FUENTE DE LUZ	Recommended bulbs Bombillas recomendadas ONLY DIMMABLE LED BULBS
230 V 50 Hz	 E27 LED Vintage- Max. 3x12 W
120 V 60 Hz	 E26 LED - Max. 3x12 W
SUPPORT SOPORTE	Stainless steel Acero inoxidable
NET WEIGHT PESO NETO	7,6 kg 16,8 lb
PACKAGING EMBALAJE	111x43x44 cm 43,7x16,9x17,3" 12,5kg 27,6lb

Virginia



Arturo Álvarez, 2021

p. 40

MATERIALS MATERIALES	Painted stainless steel Acero inoxidable pintado
FINISHES ACABADOS	White · Blanco  Beige · Beige  Grey · Gris  Taupe · Topo  Black · Negro  Custom · Personalizado 
CABLE	Transparent · Transparente L 250cm 98,4"
SUPPORT SOPORTE	Painted steel Stainless steel Acero pintado Acero inoxidable

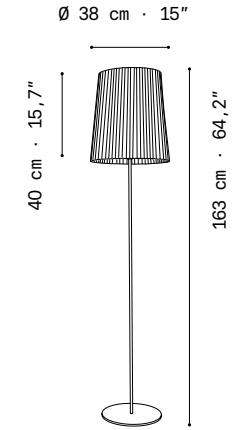

VG03A

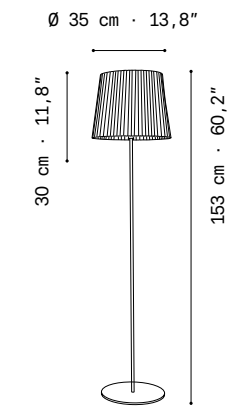

LIGHT SOURCE FUENTE DE LUZ	Recommended bulbs Bombillas recomendadas
230 V 50 Hz	 E27 LED Vintage- Max. 1x12 W
120 V 60 Hz	 E26 LED - Max. 1x12 W
CABLE	Transparent Transparente L 250cm 98,4"
NET WEIGHT PESO NETO	10,5 kg 23,1 lb
PACKAGING EMBALAJE	155x11x11 cm 61x4,3x4,3" 51x51x53 cm 20,7x20,7x20,9" 12 kg 26,5 lb

VG03B







LIGHT SOURCE FUENTE DE LUZ	Recommended bulbs Bombillas recomendadas
230 V 50 Hz	 E27 LED Vintage- Max. 1x12 W
120 V 60 Hz	 E26 LED - Max. 1x12 W
CABLE	Transparent Transparente L 250cm 98,4"
NET WEIGHT PESO NETO	10 kg 22 lb
PACKAGING EMBALAJE	1155x11x11 cm 61x4,3x4,3" 44x44x40 cm 17,3x17,3x15,7" 11,5 kg 25,3 lb

V



Héctor Serrano, 2007

p. 40

MATERIALS MATERIALES	Polycarbonate Policarbonato
FINISHES ACABADOS	White · Blanco  Black · Negro  Terracotta · Terracota  Custom · Personalizado 
CABLE	Transparent or Black Transparente o negro L 400cm 157,54" Glass diffuser Difusor de vidrio

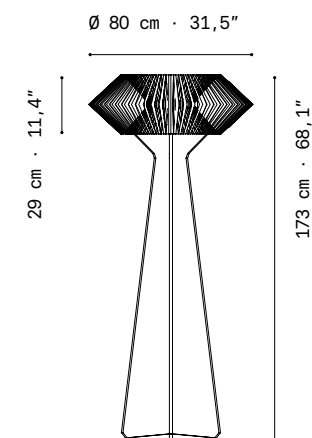
VV03



LIGHT SOURCE FUENTE DE LUZ	Recommended bulbs Bombillas recomendadas
230 V 50 Hz	 E27 LED Vintage- Max. 1x8 W
120 V 60 Hz	 E26 LED - Max. 1x8 W
NET WEIGHT PESO NETO	12 kg 26,5 lb
PACKAGING EMBALAJE	163x42x11 cm 64,2x16,5x4,3" 84x84x38 cm 33x33x15" 18,8 kg 41,4 lb

Pendant lamps

Lámparas colgantes

Aimeí

Arturo Álvarez, 2019

p. 40

MATERIALS Ash wood
MATERIALES Fresno

CABLE Transparent · Transparente
Standard: 200 cm | 78,7"
120 V: 200 cm | 78,7"

Lenght/ largo customizable

CANOPY Steel gloss nickel-plated
FLORÓN Acero niquel-satinado
230V: Ø12cm | 4,7"
120V: Ø12cm | 4,7"

DIFFUSER Glass sphere
DIFUSOR Esfera de vidrio

AIO4

LED

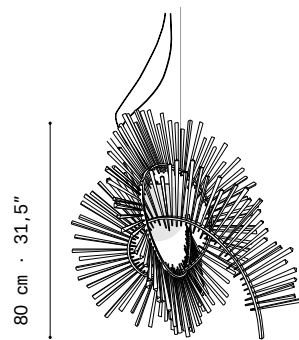

80x80 cm · 31,5x31,5"

LIGHT SOURCE Light source built in
FUENTE DE LUZ Fuente de luz incluida

230 V | 50 Hz 8W | 2700K | 960lm built in
upon request 3000K | 1067lm
Dimmer: PHASE CUT / upon
request DALI/ Switch DIM

100-277 V | 60 Hz 8W | 2700K | 960lm built in
upon request 3000K | 1067lm
Dimmer: PHASE CONTROL & 0-10V
(only 120Vac TRIAC Dimmers)

NET WEIGHT 9,5 kg | 21 lb
PESO NETO

PACKAGING 95x95x88 cm | 37,4x37,4x34,6"
EMBALAJE 20 kg | 44 lb

Agasallo

Héctor Serrano, 2021

p. 40

MATERIALS Painted Stainless steel
MATERIALES Acero inoxidable pintado

Stainless steel painted
in matt black
Acero inoxidable pintado
en negro mate

FINISHES White · Blanco (BL)

Beige · Beige (BE)

Grey · Gris (G)

Taupe · Topo (T)

Black · Negro (N)

Custom · Personalizado (CC)

CABLE Black · Negro
Standard: 150 cm | 59,1"
120 V: 200 cm | 78,7"

Lenght/Largo customizable

CABLE (EXT) Black waterproof neoprene
cable H05RN-F
Cable de neopreno negro
resistente al agua H05RN-F

Standard: 150cm | 59,1"
Lenght/largo customizable

CANOPY Steel painted in matt black
FLORÓN Acero pintado en negro mate
230V: Ø8cm | 3,1"
120V: Ø12cm | 4,7"

CANOPY (EXT) Steel and stainless steel
FLORÓN coated with epoxy paint in black
Acero y acero inoxidable
pintado en negro
Ø12cm | 4,7"

STANDARDS EN 60598
TESTED (EXT) EN 60529
NORMAS Degree IP | Grado IP
ENSAYADAS IP64

AG104

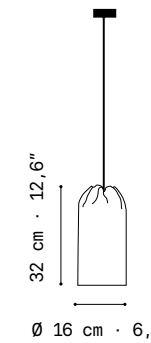

LIGHT SOURCE Recommended bulbs
FUENTE DE LUZ Bombillas recomendadas

230 V | 50 Hz E27 LED Vintage-
Max. 1x12 W

120 V | 60 Hz E26 LED - Max. 1x12
W

NET WEIGHT 0,7 kg | 1,5 lb
PESO NETO

PACKAGING 46x24x25 cm | 18,1x9,4x9,8"
EMBALAJE 1,2 kg | 2,6 lb

AG104-EXT

(EXT)

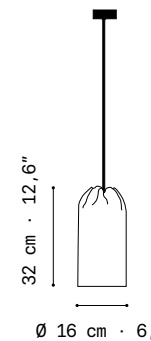

LIGHT SOURCE Recommended bulbs
FUENTE DE LUZ Bombillas recomendadas

220-240 V | E27 LED Vintage-
50/60 Hz Max. 1x15 W
BULB A60 G125 G95 ST64

Only LED BULB suitable for contact with
water and use in humid condition
Solamente Bombillas LED aptas
para el contacto con el agua y utilización
en condiciones de humedad
not available in 120V

NET WEIGHT 0,8 kg | 1,8 lb
PESO NETO

PACKAGING 46x24x25 cm | 18,1x9,4x9,8"
EMBALAJE 1,2 kg | 2,6 lb

AG204

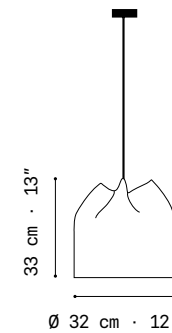

LIGHT SOURCE Recommended bulbs
FUENTE DE LUZ Bombillas recomendadas

230 V | 50 Hz E27 LED Vintage-
Max. 1x12 W

120 V | 60 Hz E26 LED - Max. 1x12 W

NET WEIGHT 1 kg | 2,2 lb
PESO NETO

PACKAGING 44x44x40 cm | 17,3x17,3x15,7"
EMBALAJE 2,6 kg | 5,7 lb

AG204-EXT

(EXT)

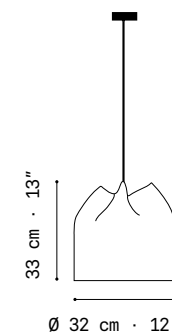

LIGHT SOURCE Recommended bulbs
FUENTE DE LUZ Bombillas recomendadas

220-240 V | E27 LED Vintage-
50/60 Hz Max. 1x15 W
BULB A60 G125 G95 ST64

Only LED BULB suitable for contact with
water and use in humid condition
Solamente Bombillas LED aptas
para el contacto con el agua y utilización
en condiciones de humedad
not available in 120V

NET WEIGHT 1,2 kg | 2,6 lb
PESO NETO

PACKAGING 44x44x40 cm | 17,3x17,3x15,7"
EMBALAJE 2,8 kg | 6,2 lb

AG304

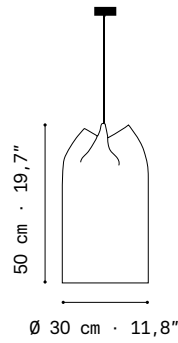

LIGHT SOURCE FUENTE DE LUZ	Recommended bulbs Bombillas recomendadas
230 V 50 Hz	E27 LED Vintage - Max. 1x12 W
120 V 60 Hz	E26 LED - Max. 1x12 W
NET WEIGHT PESO NETO	1,3 kg 2,9 lb
PACKAGING EMBALAJE	47x47x63 cm 18,5x18,5x24,8" 3,4 kg 7,5 lb

AG304-EXT

EXT

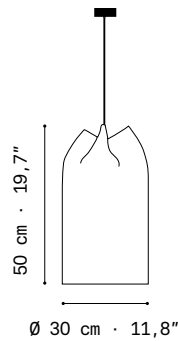

LIGHT SOURCE FUENTE DE LUZ	Recommended bulbs Bombillas recomendadas
220-240 V 50/60 Hz	E27 LED Vintage - Max. 1x15 W BULB A60 G125 G95 ST64
	Only LED BULB suitable for contact with water and use in humid condition Solamente Bombillas LED aptas para el contacto con el agua y utilización en condiciones de humedad not available in 120V
NET WEIGHT PESO NETO	1,3 kg 3,3 lb
PACKAGING EMBALAJE	47x47x63 cm 118,5x18,5x24,8" 3,6 kg 7,9 lb

AG404

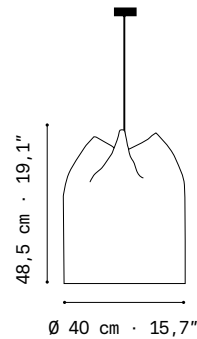

LIGHT SOURCE FUENTE DE LUZ	Recommended bulbs Bombillas recomendadas
230 V 50 Hz	E27 LED Vintage - Max. 1x12 W
120 V 60 Hz	E26 LED - Max. 1x12 W
NET WEIGHT PESO NETO	1,5 kg 3,3 lb
PACKAGING EMBALAJE	51x51x53 cm 20x20x20,9" 3,7 kg 8,2 lb

AG404-EXT

EXT

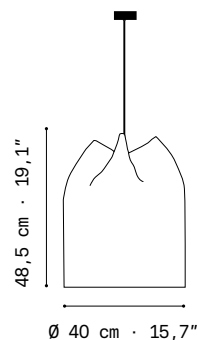

LIGHT SOURCE FUENTE DE LUZ	Recommended bulbs Bombillas recomendadas
220-240 V 50/60 Hz	E27 LED Vintage - Max. 1x15 W BULB A60 G125 G95 ST64
	Only LED BULB suitable for contact with water and use in humid condition Solamente Bombillas LED aptas para el contacto con el agua y utilización en condiciones de humedad not available in 120V
NET WEIGHT PESO NETO	1,7 kg 3,7 lb
PACKAGING EMBALAJE	51x51x53 cm 20x20x20,9" 3,9 kg 8,6 lb

Anel

a-emotional light design team, p. 40
2023MATERIALS
MATERIALES Painted stainless steel
Acero inoxidable pintadoFINISHES
ACABADOS Painted steel
Acero pintadoWhite · Blanco (BL)
Custom · Personalizado (CC)CABLE
220V: White | Blanco
110V: Transparent | Transparente
Standard: 150cm | 59,1"
120V: 200cm | 78,7"

Length/largo customizable

CANOPY
FLORÓN Steel painted in white
Acero pintado en blanco
ANO4 230V: Ø8cm | 3,1in
ANO4G 120V: Ø12cm | 4,7inSUPPORT
SOPORTE Painted steel
Acero pintadoDIFFUSER
DIFUSOR Diffuser included
Incluye difusor

ANO4

LED

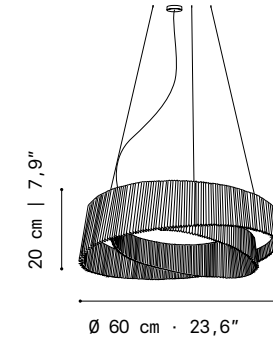

LIGHT SOURCE FUENTE DE LUZ	Light source built in Fuente de luz incluida
230 V 50 Hz	STRIP 30W 2700K 3540lm built-in Dimmer: PHASE CUT
100-277 V 60 Hz	STRIP 30W 2700K 3540lm Dimmer: 0-10 V
NET WEIGHT PESO NETO	8 kg 17,6 lb
PACKAGING EMBALAJE	73x73x31 cm 28,7x28,7x12,1" 11 kg 24,2 lb

ANO4G

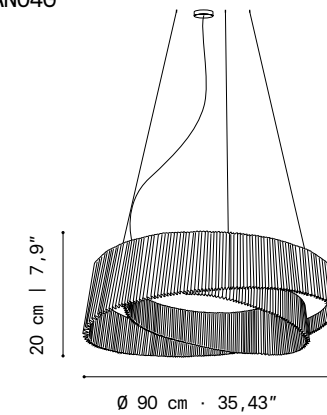

LIGHT SOURCE FUENTE DE LUZ	Light source built in Fuente de luz incluida
230 V 50 Hz	STRIP 30W 2700K 3540lm built-in Dimmer: PHASE CUT
100-277 V 60 Hz	STRIP 30W 2700K 3540lm Dimmer: 0-10 V
NET WEIGHT PESO NETO	12 kg 26,5 lb
PACKAGING EMBALAJE	110x110x33 cm 43,3x43,3x13" 16,5 kg 36,4 lb

ANO5

LED

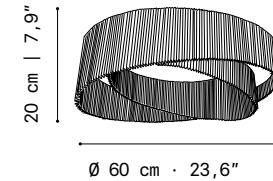

LIGHT SOURCE FUENTE DE LUZ	Light source built in Fuente de luz incluida
230 V 50 Hz	STRIP 30W 2700K 3540lm built-in Dimmer: PHASE CUT
100-277 V 60 Hz	STRIP 30W 2700K 3540lm Dimmer: 0-10 V
NET WEIGHT PESO NETO	8 kg 17,6 lb
PACKAGING EMBALAJE	73x73x31 cm 28,7x28,7x12,1" 11 kg 24,2 lb

NO CABLE

ANO5G

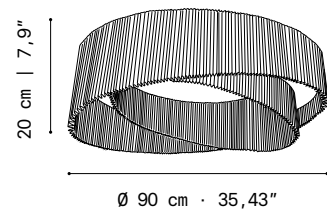

LIGHT SOURCE FUENTE DE LUZ	Light source built in Fuente de luz incluida
230 V 50 Hz	STRIP 30W 2700K 3540lm built-in Dimmer: PHASE CUT
100-277 V 60 Hz	STRIP 30W 2700K 3540lm Dimmer: 0-10 V
NET WEIGHT PESO NETO	12 kg 26,5 lb
PACKAGING EMBALAJE	110x110x33 cm 43,3x43,3x13" 16,5 kg 36,4 lb

NO CABLE

Ballet Plié

Héctor Serrano, 2016

p. 40

MATERIALS Painted Stainless steel
MATERIALES Acero inoxidable pintado

Stainless steel
Acero inoxidable pintado

FINISHES White · Blanco (BL)
ACABADOS

Beige · Beige (BE)

Grey · Gris (G)

Taupe · Topo (T)

Custom · Personalizado (CC)

CABLE Transparent or black
Transparente o negro
Standard: 150 cm | 59,1"
120 V: 200 cm | 78,7"

Lenght/Largo customizable

CABLE (EXT) Black waterproof neoprene cable H05RN-F
Cable de neopreno negro resistente al agua H05RN-F

Standard: 150cm | 59,1"
Lenght/largo customizable

CANOPY Steel gloss nickel-plated
FLORÓN Acero níquel-satinado
230V: Ø8cm | 3,1"
120V: Ø12cm | 4,7"

CANOPY (LED) Steel gloss nickel-plated
FLORÓN Acero níquel-satinado
230V: Ø12cm | 3,1"
120V: Ø12cm | 4,7"

CANOPY (EXT) Steel and stainless steel coated with epoxy paint in black
FLORÓN Acero y acero inoxidable pintado en negro
Ø12cm | 4,7"

STANDARDS EN 60598
TESTED (EXT) EN 60529
NORMAS Degree IP | Grado IP
ENSAYADAS IP64

DIFFUSER Inside diffuser
DIFUSOR (LED) Difusor interno

BAPIO4

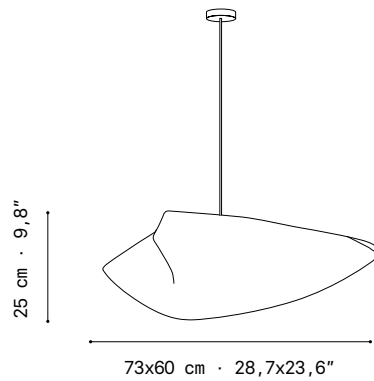

LIGHT SOURCE Recommended bulbs
FUENTE DE LUZ Bombillas recomendadas

230 V | 50 Hz (E27 LED Vintage- Max. 1x12 W)

120 V | 60 Hz (E26 LED - Max. 1x12 W)

NET WEIGHT 1,2 kg | 2,6 lb
PESO NETO

PACKAGING 60x60x33 cm | 23,6x23,6x13"
EMBALAJE 3,6 kg | 7,2 lb

BAPIO4-LD

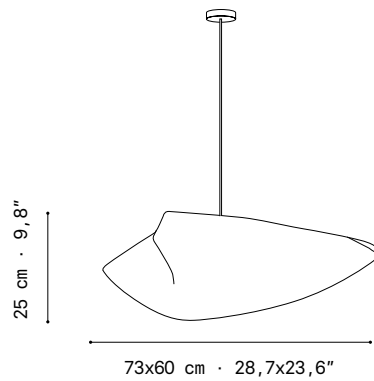

LIGHT SOURCE Light source built in
FUENTE DE LUZ Fuente de luz incluida

230 V | 50 Hz (17W | 2700K | 1645lm built in upon request 3000K | 1776lm Dimmer: PHASE CUT/ upon request DALI/ Switch DIM)

100-277 V | 60 Hz (17W | 2700K | 1645lm built in upon request 3000K | 1776lm Dimmer: PHASE CONTROL & 0-10V (only 120Vac TRIAC Dimmers))

NET WEIGHT 2,1 kg | 4,6 lb
PESO NETO

PACKAGING 60x60x33 cm | 23,6x23,6x13"
EMBALAJE 4,3 kg | 9,7 lb

BAPIO4-EXT

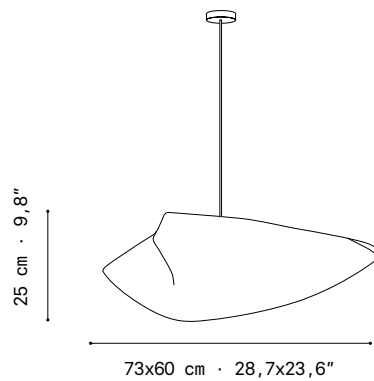

LIGHT SOURCE Recommended bulbs
FUENTE DE LUZ Bombillas recomendadas

220-240 V | 50/60 Hz (E27 LED Vintage- Max. 1x15 W BULB A60 G125 G95 ST64)

Only LED BULB suitable for contact with water and use in humid condition
Solamente Bombillas LED aptas para el contacto con el agua y utilización en condiciones de humedad not available in 120V

NET WEIGHT 2,1 kg | 4,6 lb
PESO NETO

PACKAGING 60x60x33 cm | 23,6x23,6x13"
EMBALAJE 4,3 kg | 9,7 lb

Ballet Relevé

Héctor Serrano, 2016

p. 40

MATERIALS Painted Stainless steel
MATERIALES Acero inoxidable pintado

Stainless steel
Acero inoxidable pintado

FINISHES White · Blanco (BL)
ACABADOS

Beige · Beige (BE)

Grey · Gris (G)

Taupe · Topo (T)

Custom · Personalizado (CC)

CABLE Transparent or black
Transparente o negro
Standard: 150 cm | 59,1"
120 V: 200 cm | 78,7"

Lenght/Largo customizable

CABLE (EXT) Black waterproof neoprene cable H05RN-F
Cable de neopreno negro resistente al agua H05RN-F

Standard: 150cm | 59,1"
Lenght/largo customizable

CANOPY Steel gloss nickel-plated
FLORÓN Acero níquel-satinado
230V: Ø8cm | 3,1"
120V: Ø12cm | 4,7"

CANOPY (LED) Steel gloss nickel-plated
FLORÓN Acero níquel-satinado
230V: Ø12cm | 3,1"
120V: Ø12cm | 4,7"

CANOPY (EXT) Steel and stainless steel coated with epoxy paint in black
FLORÓN Acero y acero inoxidable pintado en negro
Ø12cm | 4,7"

STANDARDS EN 60598
TESTED (EXT) EN 60529
NORMAS Degree IP | Grado IP
ENSAYADAS IP64

DIFFUSER Bottom diffuser
DIFUSOR (LED) Difusor inferior

BARE04

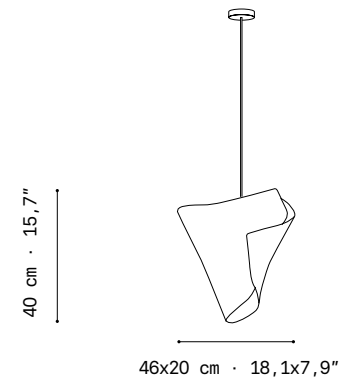

LIGHT SOURCE Recommended bulbs
FUENTE DE LUZ Bombillas recomendadas

230 V | 50 Hz (E27 LED Vintage- Max. 1x12 W)

120 V | 60 Hz (E26 LED - Max. 1x12 W)

NET WEIGHT 1 kg | 2,2 lb
PESO NETO

PACKAGING 44x44x40 cm | 17,3x17,3x15,7"
EMBALAJE 2 kg | 4,6 lb

BARE04-LD

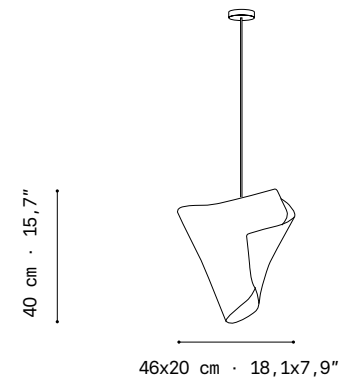

LIGHT SOURCE Light source built in
FUENTE DE LUZ Fuente de luz incluida

230 V | 50 Hz (17W | 2700K | 1645lm built in upon request 3000K | 1067lm Dimmer: PHASE CUT/ upon request DALI/ Switch DIM)

100-277 V | 60 Hz (17W | 2700K | 1645lm built in upon request 3000K | 1776lm Dimmer: PHASE CONTROL & 0-10V (only 120Vac TRIAC Dimmers))

NET WEIGHT 1,7 kg | 3,7 lb
PESO NETO

PACKAGING 44x44x40 cm | 17,3x17,3x15,7"
EMBALAJE 2,8 kg | 6,3 lb

BARE04-EXT

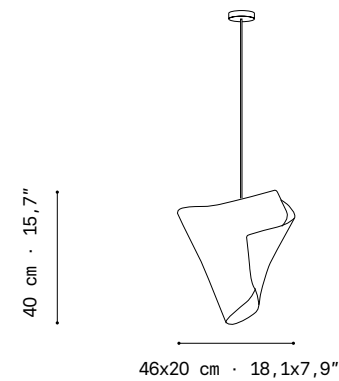

LIGHT SOURCE Recommended bulbs
FUENTE DE LUZ Bombillas recomendadas

220-240 V | 50/60 Hz (E27 LED Vintage- Max. 1x15 W BULB A60 G125 G95 ST64)

Only LED BULB suitable for contact with water and use in humid condition
Solamente Bombillas LED aptas para el contacto con el agua y utilización en condiciones de humedad not available in 120V

NET WEIGHT 1,7 kg | 3,7 lb
PESO NETO

PACKAGING 44x44x40 cm | 17,3x17,3x15,7"
EMBALAJE 2,8 kg | 6,3 lb

Ballet Elancé

Héctor Serrano, 2016

p. 40

MATERIALS Painted Stainless steel
MATERIALES Acero inoxidable pintado

Stainless steel
Acero inoxidable pintado

FINISHES White · Blanco (BL)
ACABADOS

Beige · Beige (BE)

Grey · Gris (G)

Taupe · Topo (T)

Custom · Personalizado (CC)

CABLE Transparent or black
Transparente o negro
Standard: 150 cm | 59,1"
120 V: 200 cm | 78,7"

Lenght/Largo customizable

CABLE (EXT) Black waterproof neoprene cable H05RN-F
Cable de neopreno negro resistente al agua H05RN-F

Standard: 150cm | 59,1"
Lenght/largo customizable

CANOPY Steel gloss nickel-plated
FLORÓN Acero níquel-satinado
230V: Ø8cm | 3,1"
120V: Ø12cm | 4,7"

CANOPY (LED) Steel gloss nickel-plated
FLORÓN Acero níquel-satinado
230V: Ø12cm | 3,1"
120V: Ø12cm | 4,7"

CANOPY (EXT) Steel and stainless steel coated with epoxy paint in black
FLORÓN Acero y acero inoxidable pintado en negro
Ø12cm | 4,7"

STANDARDS TESTED (EXT) EN 60598
EN 60529
NORMAS ENSAYADAS Degree IP | Grado IP

IP64

DIFFUSER (LED) Inside diffuser
DIFUSOR Difusor interno

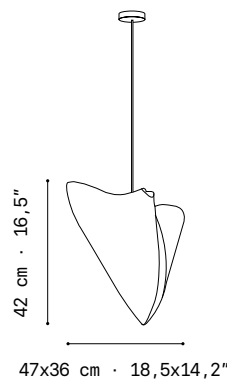

BALAO4



LIGHT SOURCE Recommended bulbs
FUENTE DE LUZ Bombillas recomendadas

230 V | 50 Hz (E27 LED Vintage- Max. 1x12 W)

120 V | 60 Hz (E26 LED - Max. 1x12 W)

NET WEIGHT 1,1 kg | 2,4 lb
PESO NETO

PACKAGING 44x44x40 cm | 17,3x17,3x15,7"
EMBALAJE 2,4 kg | 5,3 lb

BALAO4-LD

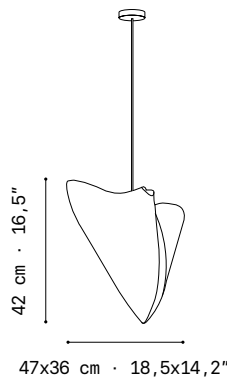

LIGHT SOURCE Light source built in
FUENTE DE LUZ Fuente de luz incluida

230 V | 50 Hz (17W | 2700K | 1645lm built in upon request 3000K | 1776lm Dimmer: PHASE CUT/ upon request DALI/ Switch DIM)

100-277 V | 60 Hz (17W | 2700K | 1645lm built in upon request 3000K | 1776lm Dimmer: PHASE CONTROL & 0-10V (only 120Vac TRIAC Dimmers))

NET WEIGHT 1,9 kg | 4,2 lb
PESO NETO

PACKAGING 44x44x40 cm | 17,3x17,3x15,7"
EMBALAJE 3,2 kg | 7 lb

BALAO4-EXT

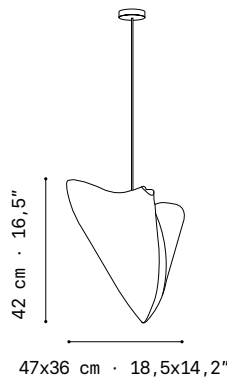

LIGHT SOURCE Recommended bulbs
FUENTE DE LUZ Bombillas recomendadas

220-240 V | 50/60 Hz (E27 LED Vintage- Max. 1x15 W BULB A60 G125 G95 ST64)

Only LED BULB suitable for contact with water and use in humid condition
Solamente Bombillas LED aptas para el contacto con el agua y utilización en condiciones de humedad not available in 120V

NET WEIGHT 1,9 kg | 4,2 lb
PESO NETO

PACKAGING 44x44x40 cm | 17,3x17,3x15,7"
EMBALAJE 3,2 kg | 7 lb

Baleira

Tomás Alonso, 2025

p. 40

MATERIALS Stainless steel mesh
MATERIALES Malla de acero inoxidable

FINISHES White · Blanco (BL)
ACABADOS

Cream · Crema (CM)

Custom · Personalizado (CC)

CABLE Black · Negro
Standard: 150 cm | 59,1"
120 V: 200 cm | 78,7"

CANOPY Black · Negro
FLORÓN Standard: 150 cm | 59,1"
120 V: 200 cm | 78,7"

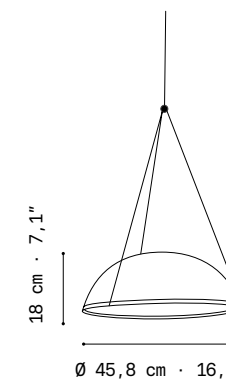

BIO4



LIGHT SOURCE Built-in LED strip
FUENTE DE LUZ Tira LED integrada

230 V | 50 Hz (27W | 2700K | 5010lm built-in: directional light 3130lm decorative light 1880lm Dimmer: PHASE CUT)

100-277 V | 60 Hz (27W | 2700K | 5010lm built-in: directional light 3130lm decorative light 1880lm Dimmer: 0-10V)

NET WEIGHT 1,5 kg | 3,3 lb
PESO NETO

PACKAGING 60x60x33 cm | 23,6x23,6x13"
EMBALAJE 3 kg | 6,6 lb

Bety Eco

Arturo Álvarez, 2009

p. 40

MATERIAL Pressed Cellulose
MATERIAL Celulosa prensada

FINISHES 42 (White) 49 (Brown)
ACABADOS

43 (Grey) 50 (Tan)

46 (Red) 51 (Green)

47 (Dark Brown) 52 (Blue)

CABLE Transparent or Black
Transparente o negro
Standard: 150 cm | 59,1"
120 V: 200 cm | 78,7"

Lenght/Largo customizable

CANOPY Steel gloss nickel-plated
FLORÓN Acero níquel-satinado
230V: Ø8cm | 3,1"
120V: Ø12cm | 4,7"

CANOPY (LED) Steel gloss nickel-plated
FLORÓN Acero níquel-satinado
230V: Ø12cm | 4,7"
120V: Ø12cm | 4,7"

BECO04

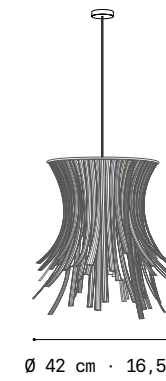

LIGHT SOURCE Recommended bulbs
FUENTE DE LUZ Bombillas recomendadas

230 V | 50 Hz (E27 LED Vintage- Max. 1x12 W)

120 V | 60 Hz (E26 LED - Max. 1x12 W)

NET WEIGHT 2,1 kg | 4,6 lb
PESO NETO

PACKAGING 47x47x63 cm | 18,5x18,5x24,8"
EMBALAJE 3 kg | 6,6 lb

BECO04-LD

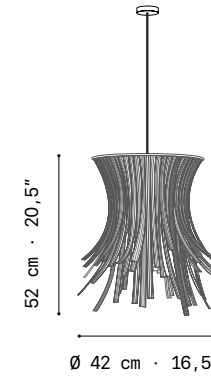

LIGHT SOURCE Light source built in
FUENTE DE LUZ Fuente de luz incluida

230 V | 50 Hz (17W | 2700K | 1645lm built in upon request 3000K | 1776lm Dimmer: PHASE CUT/ upon request DALI/ Switch DIM)

100-277 V | 60 Hz (17W | 2700K | 1645lm built in upon request 3000K | 1776lm Dimmer: PHASE CONTROL & 0-10V (only 120Vac TRIAC Dimmers))

NET WEIGHT 2,5 kg | 5,5 lb
PESO NETO

PACKAGING 47x47x63 cm | 18,5x18,5x24,8"
EMBALAJE 4 kg | 8,8 lb

Blum

Arturo Álvarez, 2015 p. 40

MATERIALS Painted Stainless thread
MATERIALES Hilo inoxidable pintado

FINISHES White · Blanco BL
ACABADOS

CABLE Transparent or Black
Transparente o negro
Standard: 150 cm | 59,1"
120 V: 200 cm | 78,7"

Lenght/Largo customizable

CANOPY Steel gloss nickel-plated
FLORÓN Acero niquel-satinado
230V: Ø8cm | 3,1"
120V: Ø12cm | 4,7"

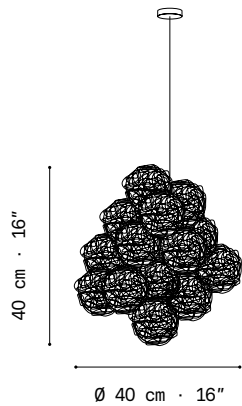

LIGHT SOURCE Recommended bulbs
FUENTE DE LUZ Bombillas recomendadas

230 V | 50 Hz E26 LED Standard-
Max. 1x12 W

120 V | 60 Hz E26 LED - Max. 1x12 W

NET WEIGHT 1,3 kg | 2,9 lb
PESO NETO

PACKAGING 44x44x40 cm | 17,3x17,3x15,7"
EMBALAJE 2,7 kg | 5,1 lb

Cabana

Isaac Piñeiro, 2023 p. 40

MATERIALS 3D Knit
MATERIALES Punto 3D

Painted aluminium
Aluminio pintado

FINISHES Beige · Beige BG
ACABADOS

Orange · Naranja NA

CABLE Black · Negro
Standard: 150 cm | 59,1"
120 V: 200 cm | 78,7"

Lenght/Largo customizable

CANOPY Steel painted in matt black
FLORÓN Acero pintado en negro mate
230V: Ø8cm | 3,1"
120V: Ø12cm | 4,7"

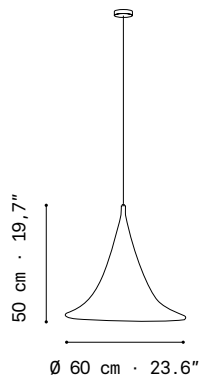

LIGHT SOURCE Recommended bulbs
FUENTE DE LUZ Bombillas recomendadas

230 V | 50 Hz E27 LED Opal- Max.
1x12 W
1521 lm recommended bulb

120 V | 60 Hz E26 LED Opal- Max.
1x12 W
1521 lm recommended bulb

NET WEIGHT 1,5 kg | 3,3 lb
PESO NETO

PACKAGING 71x71x16 cm | 28x28x6,3"
EMBALAJE 2,5 kg | 5,5 lb

CBO4G



LIGHT SOURCE Recommended bulbs
FUENTE DE LUZ Bombillas recomendadas

230 V | 50 Hz E27 LED Opal- Max.
3x12 W
1521 lm recommended bulb

120 V | 60 Hz E26 LED Opal- Max.
3 x12 W
1521 lm recommended bulb

NET WEIGHT 3,5 kg | 7,7 lb
PESO NETO

PACKAGING 102x102x17 cm | 40,1x40,1x6,7"
EMBALAJE 6,6 kg | 14,5 lb

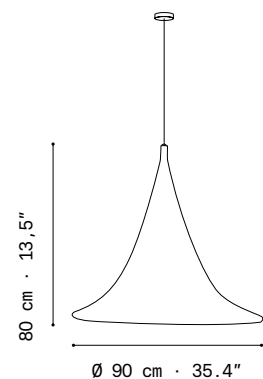

Cambo

Cenlitros, 2021 p. 40

MATERIALS Painted stainless steel
MATERIALES Acero inoxidable pintado

Beech wood
Madera de haya

Painted aluminum
Aluminio pintado

FINISHES White · Blanco BL
ACABADOS

Black · Negro N

Custom · Personalizado CC

CABLE Black · Negro
Standard: 150 cm | 59,1"
120 V: 200 cm | 78,7"

Lenght/Largo customizable

CANOPY Steel painted in matt black
FLORÓN Acero pintado en negro mate
230V: Ø12cm | 4,7"
120V: Ø12cm | 4,7"

DIFFUSER Built in diffuser
DIFUSOR Difusor incorporado

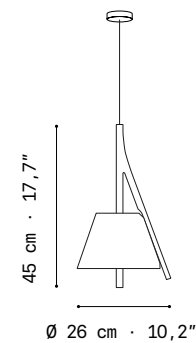

LED



LIGHT SOURCE Light source built in
FUENTE DE LUZ Fuente de luz incluida

230 V | 50 Hz 7W | 2700K | 850lm built-in
Dimmer: PHASE CUT D

100~277 V | 60 Hz 7W | 2700K | 850lm built in
Dimmer: PHASE CONTROL & 0-10V
(only 120Vac TRIAC Dimmers)

NET WEIGHT 1,2 kg | 2,1 lb
PESO NETO

PACKAGING 64x39x28 cm | 25,2x15,3x11"
EMBALAJE 2,8 kg | 6,3 lb

CM104G

LED



LIGHT SOURCE Light source built in
FUENTE DE LUZ Fuente de luz incluida

230 V | 50 Hz 7W | 2700K | 850lm built-in
Dimmer: PHASE CUT D

100~277 V | 60 Hz 7W | 2700K | 850lm built in
Dimmer: PHASE CONTROL & 0-10V
(only 120Vac TRIAC Dimmers)

NET WEIGHT 1,4 kg | 3,1 lb
PESO NETO

PACKAGING 84x39x28 cm | 33,1x15,3x11"
EMBALAJE 2,9 kg | 6,6 lb

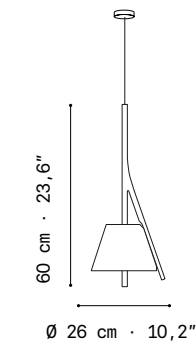

CM304

LED



LIGHT SOURCE Light source built in
FUENTE DE LUZ Fuente de luz incluida

230 V | 50 Hz 7W | 2700K | 850lm built-in
Dimmer: PHASE CUT D

100~277 V | 60 Hz 7W | 2700K | 850lm built in
Dimmer: PHASE CONTROL & 0-10V
(only 120Vac TRIAC Dimmers)

NET WEIGHT 1,4 kg | 3,1 lb
PESO NETO

PACKAGING 84x39x28 cm | 33,1x15,3x11"
EMBALAJE 2,9 kg | 6,6 lb

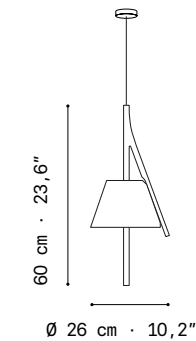

CM304G

LED



LIGHT SOURCE Light source built in
FUENTE DE LUZ Fuente de luz incluida

230 V | 50 Hz 7W | 2700K | 850lm built-in
Dimmer: PHASE CUT D

100~277 V | 60 Hz 7W | 2700K | 850lm built in
Dimmer: PHASE CONTROL & 0-10V
(only 120Vac TRIAC Dimmers)

NET WEIGHT 1,4 kg | 3,1 lb
PESO NETO

PACKAGING 84x39x28 cm | 33,1x15,3x11"
EMBALAJE 2,9 kg | 6,6 lb

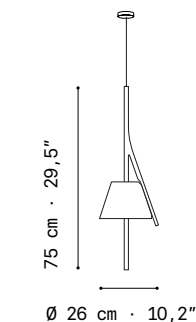









Caos

Arturo Álvarez, 2014

p. 40

MATERIAL MATERIAL Cord Cordon

Stainless steel Acero inoxidable

FINISHES ACABADOS	
42 	49 
43 	50 
46 	51 
47 	52 

CABLE Transparent or Black Transparente o negro
Standard: 150 cm | 59,1"
120 V: 200 cm | 78,7"

Lenght/Largo customizable

CANOPY FLORÓN Steel gloss nickel-plated Acero niquel-satinado
230V: Ø8cm | 3,1"
120V: Ø12cm | 4,7"

CANOPY FLORÓN  Steel gloss nickel-plated Acero niquel-satinado
230V: Ø12cm | 4,7"
120V: Ø12cm | 4,7"

DIFFUSER DIFUSOR  Bottom diffuser Difusor inferior

CA04A

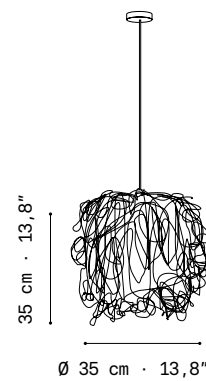

LIGHT SOURCE Recommended bulbs FUENTE DE LUZ Bombillas recomendadas

230 V | 50 Hz  E27 LED Vintage- Max. 1x12 W

120 V | 60 Hz  E26 LED - Max. 1x12 W



NET WEIGHT PESO NETO 1,1 kg | 2,4 lb

PACKAGING EMBALAJE 44x44x40 cm | 17,3x17,3x15,7"
1,5 kg | 3,3 lb

CA04A-LD



LIGHT SOURCE Light source built in FUENTE DE LUZ Fuente de luz incluida

230 V | 50 Hz  7W | 2700K | 1645lm built in upon request 3000K 1776lm Dimmer: PHASE CUT/ upon request DALI/ Switch DIM 

100-277 V | 60 Hz  7W | 2700K | 1645lm built in upon request 3000K 1776lm Dimmer: PHASE CONTROL & 0-10V (only 120Vac TRIAC Dimmers)

NET WEIGHT PESO NETO 1,8 kg | 4 lb

PACKAGING EMBALAJE 44x44x40 cm | 17,3x17,3x15,7"
2 kg | 4,6 lb

CA04B

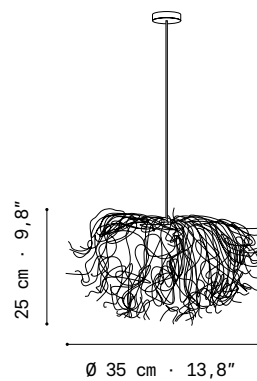

LIGHT SOURCE Recommended bulbs FUENTE DE LUZ Bombillas recomendadas

230 V | 50 Hz  E27 LED Vintage- Max. 1x12 W

120 V | 60 Hz  E26 LED - Max. 1x12 W

NET WEIGHT PESO NETO 1,1 kg | 2,4 lb

PACKAGING EMBALAJE 36x36x31 cm | 14,2x14,2x12,2"
1,5 kg | 3,3 lb

CA04B-LD

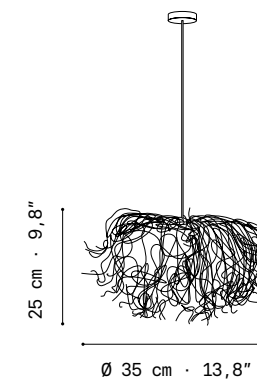

LIGHT SOURCE Light source built in FUENTE DE LUZ Fuente de luz incluida

230 V | 50 Hz  7W | 2700K | 1645lm built in upon request 3000K 1776lm Dimmer: PHASE CUT/ upon request DALI/ Switch DIM 

100-277 V | 60 Hz  7W | 2700K | 1645lm built in upon request 3000K 1776lm Dimmer: PHASE CONTROL & 0-10V (only 120Vac TRIAC Dimmers)

NET WEIGHT PESO NETO 1,7 kg | 3,7 lb

PACKAGING EMBALAJE 36x36x31 cm | 14,2x14,2x12,2"
2 kg | 4,6 lb

CA04AG

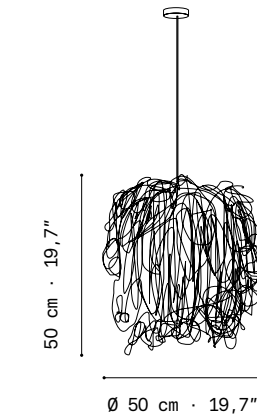

LIGHT SOURCE Recommended bulbs FUENTE DE LUZ Bombillas recomendadas

230 V | 50 Hz  E27 LED Vintage- Max. 1x12 W

120 V | 60 Hz  E26 LED - Max. 1x12 W

NET WEIGHT PESO NETO 1,7 kg | 3,7 lb

PACKAGING EMBALAJE 51x51x53 cm | 20x20x20,9"
3,8 kg | 8,6 lb

CA04AG-LD

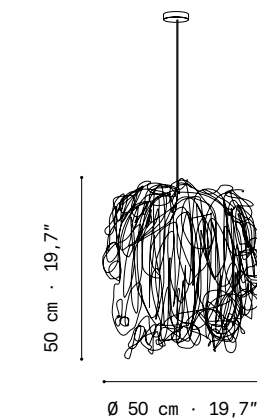

LIGHT SOURCE Light source built in FUENTE DE LUZ Fuente de luz incluida

230 V | 50 Hz  7W | 2700K | 1645lm built in upon request 3000K 1776lm Dimmer: PHASE CUT/ upon request DALI/ Switch DIM 

100-277 V | 60 Hz  7W | 2700K | 1645lm built in upon request 3000K 1776lm Dimmer: PHASE CONTROL & 0-10V (only 120Vac TRIAC Dimmers)

NET WEIGHT PESO NETO 2,3 kg | 5,1 lb

PACKAGING EMBALAJE 36x36x31 cm | 14,2x14,2x12,2"
4 kg | 8,8 lb

Coral Cay

Arturo Álvarez, 2011

p. 40

MATERIALS Painted Stainless steel
MATERIALES Acero inoxidable pintado
Stainless steel
Acero inoxidable

FINISHES White · Blanco (BL)
ACABADOS Beige · Beige (BE)
Grey · Gris (G)
Taupe · Topo (T)
Black · Negro (N)
Custom · Personalizado (CC)

CABLE Transparent or black
Transparente o negro
Standard: 150 cm | 59,1"
120 V: 200 cm | 78,7"

Lenght/Largo customizable

CANOPY Steel gloss nickel-plated
FLORÓN Acero níquel-satinado
230V: Ø8cm | 3,1"
120V: Ø12cm | 4,7"

CANOPY Steel gloss nickel-plated
FLORÓN Acero níquel-satinado
230V: Ø12cm | 4,7"
120V: Ø12cm | 4,7"

DIFFUSER Bottom diffuser
DIFUSOR Difusor inferior

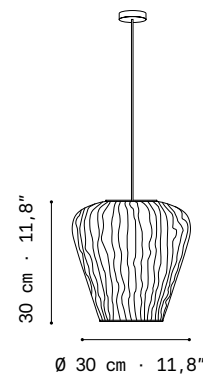

COCY04



LIGHT SOURCE Recommended bulbs
FUENTE DE LUZ Bombillas recomendadas

230 V | 50 Hz E27 LED Vintage-
Max. 1x12 W

120 V | 60 Hz E26 LED - Max. 1x12 W

NET WEIGHT 1,1 kg | 2,4 lb
PESO NETO

PACKAGING 36x36x31 cm | 14,2x14,2x12,2"
EMBALAJE 1,6 kg | 3,4 lb

COCY04-LD



LIGHT SOURCE Light source built in
FUENTE DE LUZ Fuente de luz incluida

230 V | 50 Hz 17W | 2700K | 1645lm built in
upon request 3000K 1776lm
Dimmer: PHASE CUT/
upon request DALI/ Switch DIM

100-277 V | 60 Hz 17W | 2700K | 1645lm built in
upon request 3000K 1776lm
Dimmer: PHASE CONTROL & 0-10V
(only 120Vac TRIAC Dimmers)

NET WEIGHT 1,3 kg | 2,9 lb
PESO NETO

PACKAGING 36x36x31 cm | 14,2x14,2x12,2"
EMBALAJE 2,1 kg | 4,1 lb

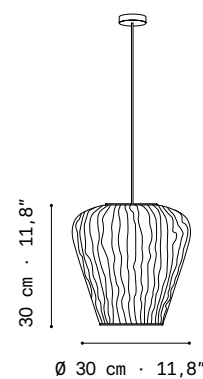

COCY04XL



LIGHT SOURCE Light source built in
FUENTE DE LUZ Fuente de luz incluida

230 V | 50 Hz 17W | 2700K | 1645lm built in
upon request 3000K 1776lm
Dimmer: PHASE CUT/
upon request DALI/ Switch DIM

100-277 V | 60 Hz 17W | 2700K | 1645lm built in
upon request 3000K 1776lm
Dimmer: PHASE CONTROL & 0-10V
(only 120Vac TRIAC Dimmers)

NET WEIGHT 6 kg | 13,2 lb
PESO NETO

PACKAGING 84x84x100 cm | 33,1x33,1x39,3"
EMBALAJE 10,4 kg | 23 lb

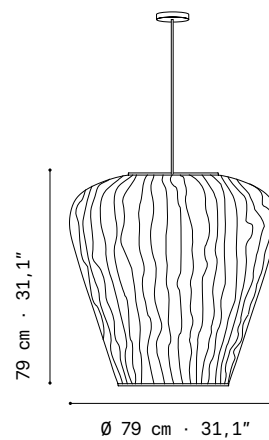

Coral Galaxea

Arturo Álvarez, 2011

p. 40

MATERIALS Painted Stainless steel
MATERIALES Acero inoxidable pintado
Stainless steel
Acero inoxidable

FINISHES White · Blanco (BL)
ACABADOS Beige · Beige (BE)
Grey · Gris (G)
Taupe · Topo (T)
Black · Negro (N)
Custom · Personalizado (CC)

CABLE Transparent or black
Transparente o negro
Standard: 150 cm | 59,1"
120 V: 200 cm | 78,7"

Lenght/Largo customizable

CANOPY Steel gloss nickel-plated
FLORÓN Acero níquel-satinado
230V: Ø8cm | 3,1"
120V: Ø12cm | 4,7"

CANOPY Steel gloss nickel-plated
FLORÓN Acero níquel-satinado
230V: Ø12cm | 4,7"
120V: Ø12cm | 4,7"

DIFFUSER Bottom diffuser
DIFUSOR Difusor inferior

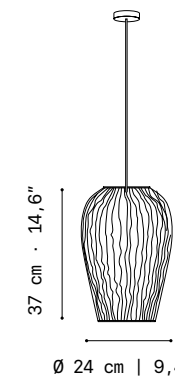

COGA04



LIGHT SOURCE Recommended bulbs
FUENTE DE LUZ Bombillas recomendadas

230 V | 50 Hz E27 LED Vintage-
Max. 1x12 W

120 V | 60 Hz E26 LED - Max. 1x12 W

NET WEIGHT 1,2 kg | 2,6 lb
PESO NETO

PACKAGING 36x36x31 cm | 14,2x14,2x12,2"
EMBALAJE 1,7 kg | 3,7 lb

COGA04-LD



LIGHT SOURCE Light source built in
FUENTE DE LUZ Fuente de luz incluida

230 V | 50 Hz 17W | 2700K | 1645lm built in
upon request 3000K | 1776lm
Dimmer: PHASE CUT/
upon request DALI/ Switch DIM

100-277 V | 60 Hz 17W | 2700K | 1645lm built in
upon request 3000K | 1776lm
Dimmer: PHASE CONTROL & 0-10V
(only 120Vac TRIAC Dimmers)

NET WEIGHT 1,9 kg | 4,2 lb
PESO NETO

PACKAGING 36x36x31 cm | 14,2x14,2x12,2"
EMBALAJE 2,7 kg | 5,9 lb

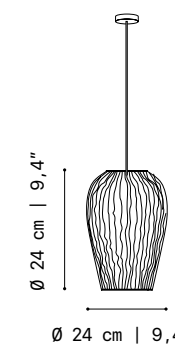

COGA04XL



LIGHT SOURCE Light source built in
FUENTE DE LUZ Fuente de luz incluida

230 V | 50 Hz 17W | 2700K | 1645lm built in
upon request 3000K | 1776lm
Dimmer: PHASE CUT/
upon request DALI/ Switch DIM

100-277 V | 60 Hz 17W | 2700K | 1645lm built in
upon request 3000K | 1776lm
Dimmer: PHASE CONTROL & 0-10V
(only 120Vac TRIAC Dimmers)

NET WEIGHT 12 kg | 26,5 lb
PESO NETO

PACKAGING 70x70x120 cm | 28x28x47,2"
EMBALAJE 18 kg | 40 lb

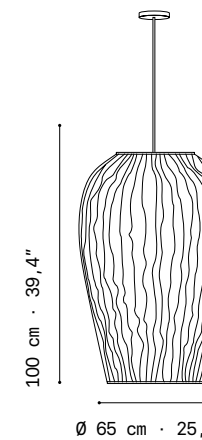

Coral Reef

Arturo Álvarez, 2011

p. 40

MATERIALS Painted Stainless steel
MATERIALES Acero inoxidable pintado
Stainless steel
Acero inoxidable

FINISHES White · Blanco (BL)
Beige · Beige (BE)
Grey · Gris (G)
Taupe · Topo (T)
Black · Negro (N)
Custom · Personalizado (CC)

CABLE Transparent or black
Transparente o negro
Standard: 150 cm | 59,1"
120 V: 200 cm | 78,7"

Lenght/Largo customizable

CANOPY Steel gloss nickel-plated
FLORÓN Acero niquel-satinado
230V: Ø8cm | 3,1"
120V: Ø12cm | 4,7"

CANOPY Steel gloss nickel-plated
FLORÓN Acero niquel-satinado
230V: Ø12cm | 4,7"
120V: Ø12cm | 4,7"

DIFFUSER Bottom diffuser
DIFUSOR Difusor inferior

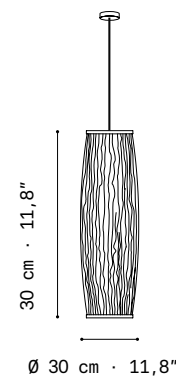

Ø 30 cm · 11,8"

CORE04



LIGHT SOURCE Recommended bulbs
FUENTE DE LUZ Bombillas recomendadas

230 V | 50 Hz E27 LED Vintage-Max. 1x12 W

120 V | 60 Hz E26 LED - Max. 1x12 W

NET WEIGHT 1,6 kg | 3,5 lb
PESO NETO

PACKAGING 65x32x23 cm | 25,5x12,6x9,1"
EMBALAJE 2,2 kg | 4,8 lb

CORE04-LD



LIGHT SOURCE Light source built in
FUENTE DE LUZ Fuente de luz incluida

230 V | 50 Hz 17W | 2700K | 1645lm built in upon request 3000K 1776lm
Dimmer: PHASE CUT/
upon request DALI/ Switch DIM

100-277 V | 60 Hz 17W | 2700K | 1645lm built in upon request 3000K 1776lm
NET WEIGHT 2,4 kg | 5,3 lb
PESO NETO Dimmer: PHASE CONTROL & 0-10V (only 120Vac TRIAC Dimmers)

PACKAGING 66x32x23 cm | 26x12,6x9,1"
EMBALAJE 2,9 kg | 6,4 lb

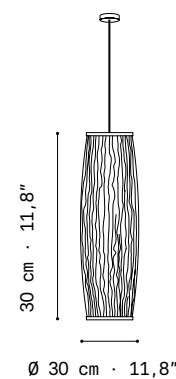

Ø 30 cm · 11,8"

CORE04XL



LIGHT SOURCE Light source built in
FUENTE DE LUZ Fuente de luz incluida

230 V | 50 Hz 17W | 2700K | 1645lm built in upon request 3000K 1776lm
Dimmer: PHASE CUT/
upon request DALI/ Switch DIM

100-277 V | 60 Hz 17W | 2700K | 1645lm built in upon request 3000K 1776lm
NET WEIGHT 9,6 kg | 21,2 lb
PESO NETO Dimmer: PHASE CONTROL & 0-10V (only 120Vac TRIAC Dimmers)

PACKAGING 64x64x180 cm | 25,2x25,2x71"
EMBALAJE 19,2 kg | 42,3 lb

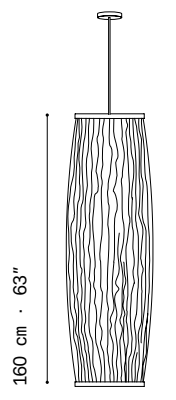

Ø 53,5 cm · 21,1"

Coral Sea

Arturo Álvarez, 2011

p. 40

MATERIALS Painted Stainless steel
MATERIALES Acero inoxidable pintado
Stainless steel
Acero inoxidable

FINISHES White · Blanco (BL)
Beige · Beige (BE)
Grey · Gris (G)
Taupe · Topo (T)
Black · Negro (N)
Custom · Personalizado (CC)

CABLE Transparent or black
Transparente o negro
Standard: 150 cm | 59,1"
120 V: 200 cm | 78,7"

Lenght/Largo customizable

CANOPY Steel gloss nickel-plated
FLORÓN Acero niquel-satinado
230V: Ø8cm | 3,1"
120V: Ø12cm | 4,7"

CANOPY Steel gloss nickel-plated
FLORÓN Acero niquel-satinado
230V: Ø12cm | 4,7"
120V: Ø12cm | 4,7"

DIFFUSER Bottom diffuser
DIFUSOR Difusor inferior

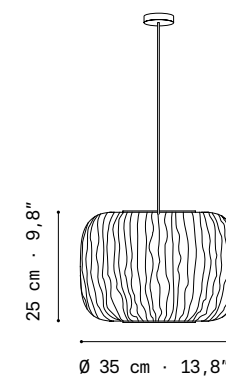

Ø 35 cm · 13,8"

COSE04



LIGHT SOURCE Recommended bulbs
FUENTE DE LUZ Bombillas recomendadas

230 V | 50 Hz E27 LED Vintage-Max. 1x12 W

120 V | 60 Hz E26 LED - Max. 1x12 W

NET WEIGHT 1,4 kg | 3,1 lb
PESO NETO

PACKAGING 36x36x31 cm | 14,2x14,2x12,2"
EMBALAJE 2 kg | 4,4 lb

COSE04-LD



LIGHT SOURCE Light source built in
FUENTE DE LUZ Fuente de luz incluida

230 V | 50 Hz 17W | 2700K | 1645lm built in upon request 3000K 1776lm
Dimmer: PHASE CUT/
upon request DALI/ Switch DIM

100-277 V | 60 Hz 17W | 2700K | 1645lm built in upon request 3000K 1776lm
NET WEIGHT 1,9 kg | 4,2 lb
PESO NETO Dimmer: PHASE CONTROL & 0-10V (only 120Vac TRIAC Dimmers)

PACKAGING 44x44x40 cm | 17,3x17,3x15,7"
EMBALAJE 2,5 kg | 5,5 lb

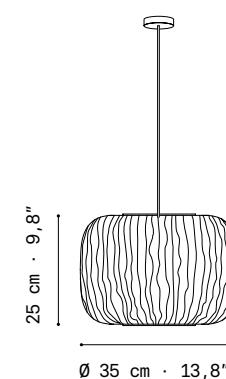

Ø 35 cm · 13,8"

COSE04XL



LIGHT SOURCE Light source built in
FUENTE DE LUZ Fuente de luz incluida

230 V | 50 Hz 17W | 2700K | 1645lm built in upon request 3000K 1776lm
Dimmer: PHASE CUT/
upon request DALI/ Switch DIM

100-277 V | 60 Hz 17W | 2700K | 1645lm built in upon request 3000K 1776lm
NET WEIGHT 7,6 kg | 17 lb
PESO NETO Dimmer: PHASE CONTROL & 0-10V (only 120Vac TRIAC Dimmers)

PACKAGING 105x105x87 cm | 41,3x41,3x34,3"
EMBALAJE 14,2 kg | 31,3 lb

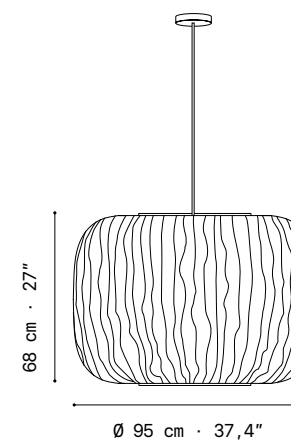

Ø 95 cm · 37,4"

Coral Searchin

Arturo Álvarez, 2011

p. 40

MATERIALS Painted Stainless steel
MATERIALES Acero inoxidable pintado
Stainless steel
Acero inoxidable

FINISHES White · Blanco (BL)
ACABADOS Beige · Beige (BE)
Grey · Gris (G)
Taupe · Topo (T)
Black · Negro (N)
Custom · Personalizado (CC)

CABLE Transparent or black
Transparente o negro
Standard: 150 cm | 59,1"
120 V: 200 cm | 78,7"

Lenght/Largo customizable

CANOPY Steel gloss nickel-plated
FLORÓN Acero niquel-satinado
230V: Ø8cm | 3,1"
120V: Ø12cm | 4,7"

CANOPY Steel gloss nickel-plated
FLORÓN Acero niquel-satinado
230V: Ø12cm | 4,7"
120V: Ø12cm | 4,7"

DIFFUSER Bottom diffuser
DIFUSOR Difusor inferior

COAU04

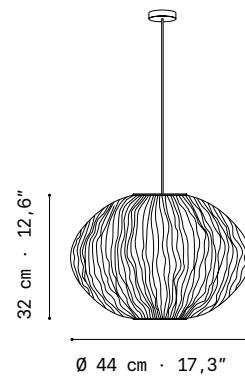

LIGHT SOURCE Recommended bulbs
FUENTE DE LUZ Bombillas recomendadas

230 V | 50 Hz E27 LED Vintage-
Max. 1x12 W

120 V | 60 Hz E26 LED - Max. 1x12 W

NET WEIGHT 1,7 kg | 3,7 lb
PESO NETO

PACKAGING 44x44x40 cm | 17,3x17,3x15,7"
EMBALAJE 2,9 kg | 6,4 lb

COAU04-LD

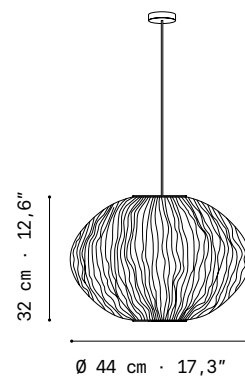

LIGHT SOURCE Light source built in
FUENTE DE LUZ Fuente de luz incluida

230 V | 50 Hz 17W | 2700K | 1645lm built in
upon request 3000K 1776lm
Dimmer: PHASE CUT/
upon request DALI/ Switch DIM

100~277 V | 60 Hz 17W | 2700K | 1645lm built in
upon request 3000K 1776lm
Dimmer: PHASE CONTROL & 0-10V
(only 120Vac TRIAC Dimmers)

NET WEIGHT 2,4 kg | 5,3 lb
PESO NETO

PACKAGING 44x44x40 cm | 17,3x17,3x15,7"
EMBALAJE 3 kg | 6,9 lb

COAU04XL

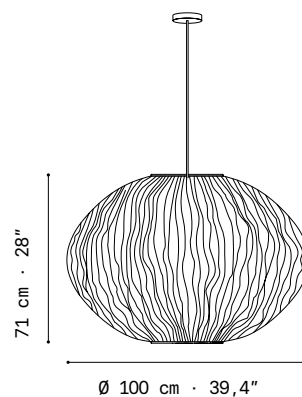

LIGHT SOURCE Light source built in
FUENTE DE LUZ Fuente de luz incluida

230 V | 50 Hz 17W | 2700K | 1645lm built in
upon request 3000K 1776lm
Dimmer: PHASE CUT/
upon request DALI/ Switch DIM

100~277 V | 60 Hz 17W | 2700K | 1645lm built in
upon request 3000K 1776lm
Dimmer: PHASE CONTROL & 0-10V
(only 120Vac TRIAC Dimmers)

NET WEIGHT 10 kg | 22 lb
PESO NETO

PACKAGING 110x110x90 cm | 43,3x43,3x35,4"
EMBALAJE 18 kg | 40 lb

COAU04G

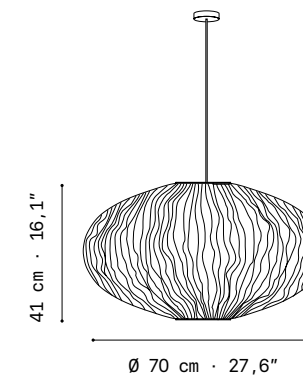

LIGHT SOURCE Recommended bulbs
FUENTE DE LUZ Bombillas recomendadas

230 V | 50 Hz E27 LED Vintage-
Max. 4x12 W

120 V | 60 Hz E26 LED - Max. 4x12 W

NET WEIGHT 4,5 kg | 9,9 lb
PESO NETO

PACKAGING 71x71x43 cm | 28x28x17"
EMBALAJE 7,2 kg | 15,9 lb

COAU04G-LD

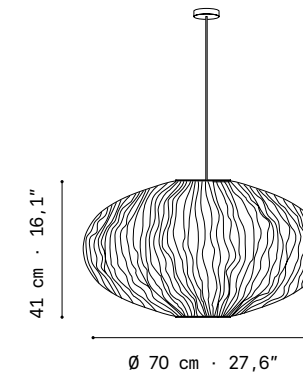

LIGHT SOURCE Light source built in
FUENTE DE LUZ Fuente de luz incluida

230 V | 50 Hz 35W | 2700K | 3938lm built in
upon request 3000K 4086lm
Dimmer: PHASE CUT/
upon request DALI/ Switch DIM

100~277 V | 60 Hz 35W | 2700K | 3938lm built in
upon request 3000K 4086lm
Dimmer: PHASE CONTROL & 0-10V

NET WEIGHT 4,5 kg | 9,9 lb
PESO NETO

PACKAGING 71x71x43 cm | 28x28x17"
EMBALAJE 8 kg | 17,6 lb

Curvas

Arturo Álvarez, 2004

p. 40

MATERIALS
MATERIALES

Glass
Vidrio

FINISHES
ACABADOS

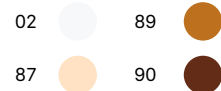

CABLE
Transparent or black
Transparente o negro
Standard: 150 cm | 59,1"
120 V: 200 cm | 78,7"

Lenght/Largo customizable

CANOPY
FLORÓN
Steel gloss nickel-plated
Acero niquel-satinado
230V: Ø8cm | 3,1"
120V: Ø12cm | 4,7"

CANOPY
FLORÓN
CV04|CV04G
Steel gloss nickel-plated
Acero niquel-satinado
230V: Ø12cm | 4,7"
120V: Ø12cm | 4,7"

DIFFUSER
DIFUSOR
Top and bottom diffuser
Difusor superior e inferior

CV04-1

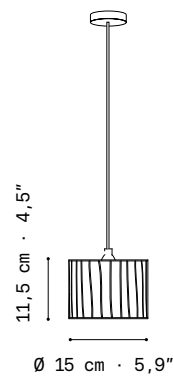

LIGHT SOURCE
FUENTE DE LUZ
Recommended bulbs
Bombillas recomendadas

230 V | 50 Hz E14 LED Vintage-
Max. 1x7 W

120 V | 60 Hz E12 LED - Max. 1x7 W

NET WEIGHT
PESO NETO
0,7 kg | 1,5 lb

PACKAGING
EMBALAJE
21x21x22 cm | 8,3x8,3x8,7"
1,7 kg | 3,7 lb

CV04

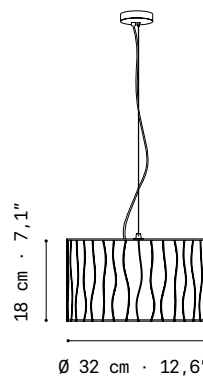

LIGHT SOURCE
FUENTE DE LUZ
Recommended bulbs
Bombillas recomendadas

230 V | 50 Hz E27 LED Vintage-
Max. 1x8 W

120 V | 60 Hz E26 LED - Max. 1x8 W

NET WEIGHT
PESO NETO
2,1 kg | 4,6 lb

PACKAGING
EMBALAJE
44x44x40 cm | 17,3x17,3x15,7"
4,4 kg | 9,7 lb

Bottom diffuser
Difusor inferior

CV04G

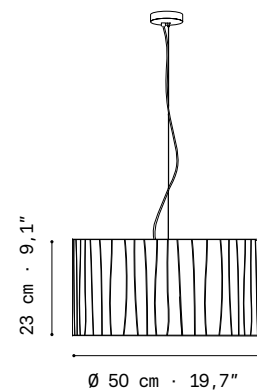

LIGHT SOURCE
FUENTE DE LUZ
Recommended bulbs
Bombillas recomendadas

230 V | 50 Hz E27 LED Vintage-
Max. 4x12 W

120 V | 60 Hz E26 LED - Max. 4x12 W

NET WEIGHT
PESO NETO
5,6 kg | 12,3 lb

PACKAGING
EMBALAJE
60x80x45 cm | 23,6x31,5x17,7"
12,4 kg | 27,3 lb

Top and bottom diffuser
Difusor inferior
e inferior

Fluo

Arturo Álvarez, 2009

p. 40

MATERIALS
MATERIALES
Galvanized painted steel
Acero galvanizado pintado

FINISHES
ACABADOS
White · Blanco (BL)

Custom · Personalizado (CC)

CABLE
Transparent or black
Transparente o negro
Standard: 150 cm | 59,1"
120 V: 200 cm | 78,7"

Lenght/Largo customizable

CANOPY
FLORÓN
Steel gloss nickel-plated and Stainless steel
Acero niquel-satinado
y acero inoxidable
230V: Ø12cm | 4,7"
120V: Ø12cm | 4,7"

FL04



LIGHT SOURCE
FUENTE DE LUZ
Recommended bulbs
Bombillas recomendadas

230 V | 50 Hz E27 LED Vintage-
Max. 1x12 W

120 V | 60 Hz E26 LED - Max. 1x12 W

NET WEIGHT
PESO NETO
3,3 kg | 7,3 lb

PACKAGING
EMBALAJE
76x81x78 cm | 29,9x31,9x30,7"
9,8 kg | 21,6 lb

Gea

Arturo Álvarez, 2009

p. 40

MATERIALS
MATERIALES
Painted Stainless steel
Acero inoxidable pintado

FINISHES
ACABADOS
White · Blanco (BL)

Beige · Beige (BE)

Grey · Gris (G)

Taupe · Topo (T)

Black · Negro (N)

Custom · Personalizado (CC)

CABLE
Transparent or black
Transparente o negro
Standard: 150 cm | 59,1"
120 V: 200 cm | 78,7"

Lenght/Largo customizable

CANOPY
FLORÓN
Steel gloss nickel-plated
Acero niquel-satinado
230V: Ø8cm | 3,1"
120V: Ø12cm | 4,7"

CANOPY
FLORÓN
LED
Steel gloss nickel-plated
Acero niquel-satinado
230V: Ø12cm | 4,7"
120V: Ø12cm | 4,7"

DIFFUSER
DIFUSOR
LED
Bottom diffuser
Difusor inferior

GE04

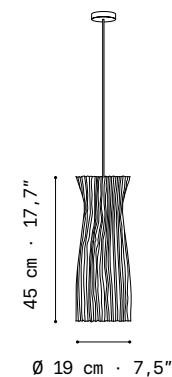

LIGHT SOURCE
FUENTE DE LUZ
Recommended bulbs
Bombillas recomendadas

230 V | 50 Hz E27 LED Vintage-
Max. 1x12 W

120 V | 60 Hz E26 LED - Max. 1x12 W

NET WEIGHT
PESO NETO
1,1 kg | 2,4 lb

PACKAGING
EMBALAJE
65x32x23 cm | 25,9x12,6x9,1"
2 kg | 4,4 lb

CABLE
Transparent or black
Transparente o negro
Standard: 150 cm | 59,1"
120 V: 200 cm | 78,7"

Lenght/Largo customizable

CANOPY
FLORÓN
Steel gloss nickel-plated
Acero niquel-satinado
230V: Ø8cm | 3,1"
120V: Ø12cm | 4,7"

CANOPY
FLORÓN
LED
Steel gloss nickel-plated
Acero niquel-satinado
230V: Ø12cm | 4,7"
120V: Ø12cm | 4,7"

DIFFUSER
DIFUSOR
LED
Bottom diffuser
Difusor inferior

GE04-LD

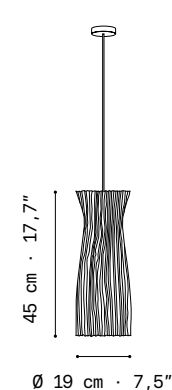

LIGHT SOURCE
FUENTE DE LUZ
Light source built in
Fuente de luz incluida

230 V | 50 Hz 17W | 2700K | 1645lm built in
upon request 3000K 1776lm
Dimmer: PHASE CUT/
upon request DALI/ Switch DIM

100-277 V |
60 Hz 17W | 2700K | 1645lm built in
upon request 3000K 1776lm
Dimmer: PHASE CONTROL & 0-10V
(only 120Vac TRIAC Dimmers)

NET WEIGHT
PESO NETO
1,9 kg | 4,2 lb

PACKAGING
EMBALAJE
65x32x23 cm | 25,9x12,6x9,1"
2,5 kg | 5,8 lb

Bottom diffuser
Difusor inferior

CABLE EXT Black waterproof neoprene cable H05RN-F
Cable de neopreno negro resistente al agua H05RN-F

Standard: 150cm | 59,1"
Lenght/largo customizable

CANOPY FLORÓN EXT Steel and stainless steel coated with epoxy paint in black
Acero y acero inoxidable pintado en negro
Ø12cm | 4,7"

STANDARDS TESTED EXT EN 60598
EN 60529
NORMAS ENSAYADAS Degree IP | Grado IP
IP64

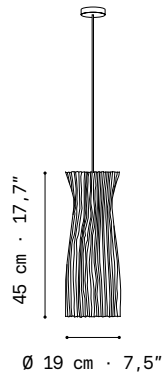

LIGHT SOURCE EXT Recommended bulbs
FUENTE DE LUZ Bombillas recomendadas

220-240 V | 50/60 Hz E27 LED Vintage-
Max. 1x15 W
BULB A60 G125 G95 ST64

Only LED BULB suitable for contact with water and use in humid condition
Solamente Bombillas LED aptas para el contacto con el agua y utilización en condiciones de humedad not available in 120V

NET WEIGHT EXT 2,1kg | 4,6lb
PESO NETO

PACKAGING 65x32x23 cm | 25,9x12,6x9,1"
EMBALAJE 2,4 kg | 5,5 lb

Inn

a-emotional light design team, p. 40
2021

MATERIALS Painted stainless steel
MATERIALES Acero inoxidable pintado

Steel painted in black
Acero pintado en negro

FINISHES BL White · Blanco
ACABADOS

G Grey · Gris

BE Beige · Beige

T Taupe · Topo

Custom · Personalizado CC

CABLE Black · Negro
Standard: 150 cm | 59,1"
120 V: 200 cm | 78,7"

Lenght/Largo customizable

CANOPY FLORÓN Steel painted in matt black
Acero pintado en negro mate
230V: Ø8cm | 3,1"
120V: Ø12cm | 4,7"

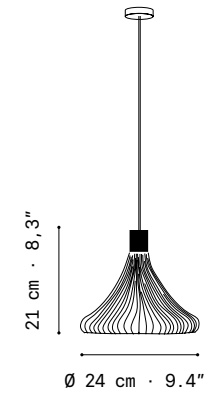

LIGHT SOURCE Recommended bulbs
FUENTE DE LUZ Bombillas recomendadas

230 V | 50 Hz E14 LED Vintage-
Max. 1x12 W

120 V | 60 Hz E12 LED - Max. 1x12 W

NET WEIGHT 0,7 kg | 1,5 lb
PESO NETO

PACKAGING 36x36x31 cm | 14,2x14,2x12,2"
EMBALAJE 1 kg | 2,2 lb

INO4-Mini



INO4



LIGHT SOURCE Recommended bulbs
FUENTE DE LUZ Bombillas recomendadas

230 V | 50 Hz E27 LED Vintage-
Max. 4x12 W

120 V | 60 Hz E26 LED - Max. 4x12 W

NET WEIGHT 1,2 kg | 2,6 lb
PESO NETO

PACKAGING 44x44x40 cm | 17,3x17,3x15,7"
EMBALAJE 2,8 kg | 6,2 lb

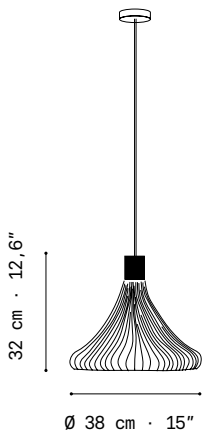

Lea

Rafa Alonso, 2021 p. 40

MATERIALS Painted stainless steel
MATERIALES Acero inoxidable pintado

Stainless steel
Acero inoxidable

FINISHES BL White · Blanco
ACABADOS

G Grey · Gris

Custom · Personalizado CC

CABLE Transparent or black
Transparente o negro
Standard: 150 cm | 59,1"
120 V: 200 cm | 78,7"

Lenght/Largo customizable

CANOPY FLORÓN Steel gloss nickel-plated and Stainless steel
Acero niquel-satinado y acero inoxidable
230V: Ø8cm | 3,1"
120V: Ø12cm | 4,7"

CANOPY FLORÓN LED Steel gloss nickel-plated and Stainless steel
Acero niquel-satinado y acero inoxidable
230V: Ø12cm | 4,7"
120V: Ø12cm | 4,7"

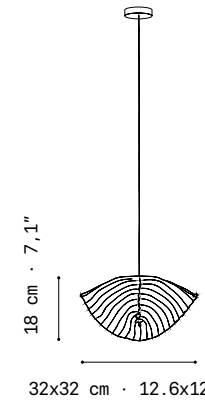

LIGHT SOURCE Recommended bulbs
FUENTE DE LUZ Bombillas recomendadas

230 V | 50 Hz E14 LED Vintage-
Max. 1x12 W

120 V | 60 Hz E12 LED - Max. 1x12 W

NET WEIGHT 0,8 kg | 1,8 lb
PESO NETO

PACKAGING 36x36x31 cm | 14,2x14,2x12,2"
EMBALAJE 1,2 kg | 2,6 lb

LAO4-Mini



LAO4-Mini-LD



LIGHT SOURCE Light source built in
FUENTE DE LUZ Fuente de luz incluida

230 V | 50 Hz 8W | 2700K | 960lm built in
upon request 3000K 1067lm
Dimmer: PHASE CUT

100-277 V | 60 Hz 8W | 2700K | 960lm built in
upon request 3000K 1067lm
Dimmer: PHASE CONTROL & 0-10V
(only 120Vac TRIAC Dimmers)

NET WEIGHT 1 kg | 2,2 lb
PESO NETO

PACKAGING 36x36x31 cm | 14,2x14,2x12,2"
EMBALAJE 1,4 kg | 3,1 lb

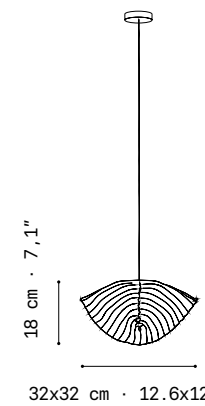

LAO4



LIGHT SOURCE Recommended bulbs
FUENTE DE LUZ Bombillas recomendadas

230 V | 50 Hz E26 LED Vintage-
Max. 1x12 W

120 V | 60 Hz E27 LED - Max. 1x12 W

NET WEIGHT 1 kg | 2,2 lb
PESO NETO

PACKAGING 36x36x31 cm | 14,2x14,2x12,2"
EMBALAJE 1,9 kg | 4,2 lb

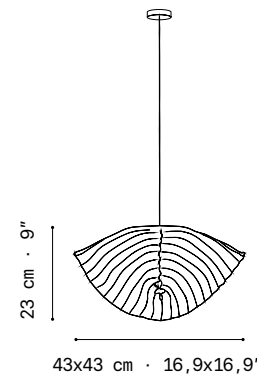

LA04-LD

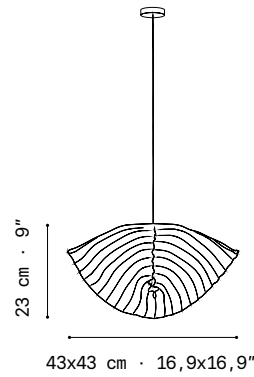

LIGHT SOURCE Fuente de luz incluida
Light source built in Fuente de luz incluida

230 V | 50 Hz
 12W | 2700K | 1151lm built in upon request 3000K 12431m
 Dimmer: PHASE CUT

100-277 V | 60 Hz
 12W | 2700K | 1133lm built in upon request 3000K 16551m
 Dimmer: PHASE CONTROL & 0-10V (only 120Vac TRIAC Dimmers)

NET WEIGHT PESO NETO 1,5 kg | 3,3 lb

PACKAGING EMBALAJE 36x36x31 cm | 14,2x14,2x12,2" 2,4 kg | 5,3 lb

LA04G

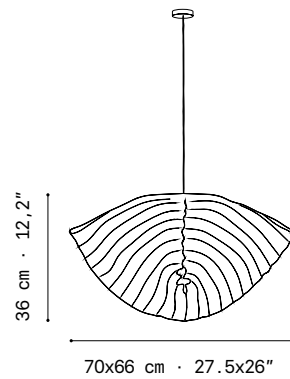

LIGHT SOURCE Fuente de luz
Recommended bulbs Bombillas recomendadas

230 V | 50 Hz
 E27 LED Vintage- Max. 3x12 W

120 V | 60 Hz
 E26 LED - Max. 3x12 W

NET WEIGHT PESO NETO 2,1 kg | 4,6 lb

PACKAGING EMBALAJE 51x51x53 cm | 20x20x20,9" 4,4 kg | 9,7 lb

LA04G-LD

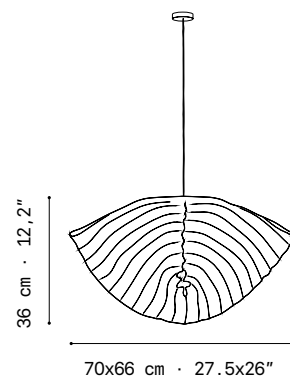

LIGHT SOURCE Fuente de luz incluida
Light source built in Fuente de luz incluida

230 V | 50 Hz
 12W | 2700K | 1151lm built in upon request 3000K 12431m
 Dimmer: PHASE CUT/ upon request DALI/ Switch DIM

100-277 V | 60 Hz
 12W | 2700K | 1645lm built in upon request 3000K 17761m
 Dimmer: PHASE CONTROL & 0-10V (only 120Vac TRIAC Dimmers)

NET WEIGHT PESO NETO 2,3 kg | 5,1 lb

PACKAGING EMBALAJE 51x51x53 cm | 20x20x20,9" 4,6 kg | 10,1 lb

Luisa

Arturo Álvarez, 2015

p. 40

MATERIALS MATERIALES Painted stainless steel Acero inoxidable pintado

Stainless steel Acero inoxidable

FINISHES ACABADOS White · Blanco (BL)

Beige · Beige (BE)

Grey · Gris (G)

Taupe · Topo (T)

Black · Negro (N)

Custom · Personalizado (CC)

CABLE Transparente
Transparente
Standard: 150 cm | 59,1"
120 V: 200 cm | 78,7"

Lenght/Largo customizable

CANOPY FLORÓN Steel gloss nickel-plated Acero níquel-satinado
230V: Ø8cm | 3,1"
120V: Ø12cm | 4,7"

CANOPY FLORÓN Steel gloss nickel-plated Acero níquel-satinado
230V: Ø12cm | 4,7"
120V: Ø12cm | 4,7"

DIFFUSER DIFUSOR Bottom diffuser Difusor inferior

LS04

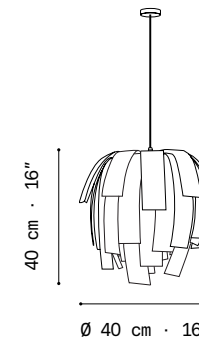

LIGHT SOURCE Fuente de luz
Recommended bulbs Bombillas recomendadas

230 V | 50 Hz
 E27 LED Vintage- Max. 1x12 W

120 V | 60 Hz
 E26 LED - Max. 1x12 W

NET WEIGHT PESO NETO 1,6 kg | 3,5 lb

PACKAGING EMBALAJE 44x44x40 cm | 17,3x17,3x15,7" 3 kg | 6,6 lb

LS04-LD

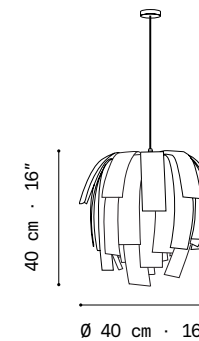

LIGHT SOURCE Fuente de luz incluida
Light source built in Fuente de luz incluida

230 V | 50 Hz
 12W | 2700K | 1151lm built in upon request 3000K 12431m
 Dimmer: PHASE CUT/ upon request DALI/ Switch DIM

100-277 V | 60 Hz
 12W | 2700K | 1645lm built in upon request 3000K 17761m
 Dimmer: PHASE CONTROL & 0-10V (only 120Vac TRIAC Dimmers)

NET WEIGHT PESO NETO 2,4 kg | 5,3 lb

PACKAGING EMBALAJE 44x44x40 cm | 17,3x17,3x15,7" 3,5 kg | 7,1 lb

LS04G

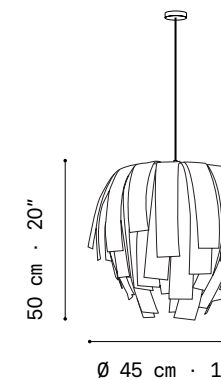

LIGHT SOURCE Fuente de luz
Recommended bulbs Bombillas recomendadas

230 V | 50 Hz
 E27 LED Vintage- Max. 1x12 W

120 V | 60 Hz
 E26 LED - Max. 1x12 W

NET WEIGHT PESO NETO 2,7 kg | 6 lb

PACKAGING EMBALAJE 51x51x53 cm | 20x20x20,9" 4 kg | 9 lb

LS04G-LD

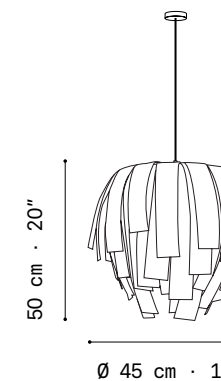

LIGHT SOURCE Fuente de luz incluida
Light source built in Fuente de luz incluida

230 V | 50 Hz
 12W | 2700K | 1151lm built in upon request 3000K 12431m
 Dimmer: PHASE CUT/ upon request DALI/ Switch DIM

100-277 V | 60 Hz
 12W | 2700K | 1645lm built in upon request 3000K 17761m
 Dimmer: PHASE CONTROL & 0-10V (only 120Vac TRIAC Dimmers)

NET WEIGHT PESO NETO 3,3 kg | 7,3 lb

PACKAGING EMBALAJE 51x51x53 cm | 20x20x20,9" 4,6 kg | 10,1 lb

Mytilus

Arturo Álvarez, 2019

p. 40

MATERIALS Painted stainless steel
MATERIALES Acero inoxidable pintado

Stainless steel
Acero inoxidable

FINISHES White · Blanco (BL)
ACABADOS Black · Negro (N)

CABLE Transparent
Transparente
Standard: 150 cm | 59,1"
120 V: 200 cm | 78,7"

Lenght/Largo customizable

CANOPY Steel painted in black
FLORÓN or white
Acero pintado en negro
o blanco
230V: Ø14,2cm | 5,6"
120V: Ø14,2cm | 5,6"

DIFFUSER Glass sphere
DIFUSOR Esfera de vidrio
*approximate measurements
medidas aproximadas

MYO4

LED

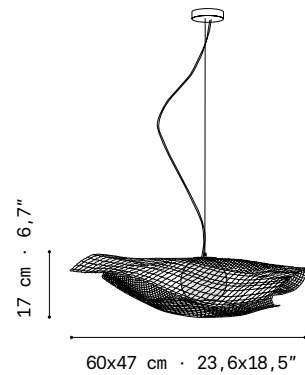

LIGHT SOURCE Light source built in
FUENTE DE LUZ Fuente de luz incluida

230 V | 50 Hz 8W | 2700K | 960lm built in
upon request 3000K 1067lm
Dimmer: PHASE CUT
upon request DALI/ Switch DIM

100~277 V | 60 Hz 8W | 2700K | 960lm built in
upon request 3000K 1067lm
Dimmer: PHASE CONTROL & 0-10V
(only 120Vac TRIAC Dimmers)

NET WEIGHT 3 kg | 6,6 lb
PESO NETO

PACKAGING 60x60x22 cm | 23,6x23,6x8,7"
EMBALAJE 5,5 kg | 12,1 lb

MYO4G

LED

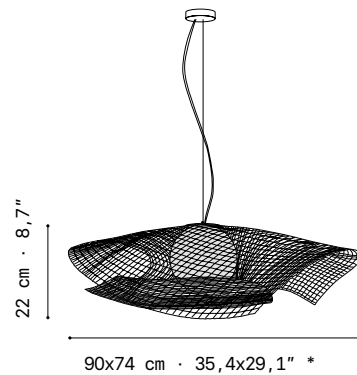

LIGHT SOURCE Light source built in
FUENTE DE LUZ Fuente de luz incluida

230 V | 50 Hz 8W | 2700K | 960lm built in
upon request 3000K 1067lm
Dimmer: PHASE CUT
upon request DALI/ Switch DIM

100~277 V | 60 Hz 8W | 2700K | 960lm built in
upon request 3000K 1067lm
Dimmer: PHASE CONTROL & 0-10V
(only 120Vac TRIAC Dimmers)

NET WEIGHT 7,4 kg | 16,5 lb
PESO NETO

PACKAGING 82x97x30 cm | 32,3x38,2x11,8"
EMBALAJE 7,6 kg | 16,7 lb

Nebra

Cenlitros, 2019

p. 40

MATERIALS Painted stainless steel
MATERIALES Acero inoxidable pintado

Steel painted in black
Acero pintado en negro

FINISHES Inox (INOX)
ACABADOS Taupe · Topo (T) Custom · Personalizado (CC)

CABLE Black · Negro
Standard
Over all Height: 150 cm | 59,1"
120 V: 200 cm | 78,7"

Lenght/Largo customizable

CANOPY Black · Negro
FLORÓN 230V: 30x5x2cm | 11,8x1,9x0,8"
120V: 30x12x2cm | 11,8x4,7x0,8"

DIFFUSER Bottom & interior
DIFUSOR Inferior e interior

NB04

LED

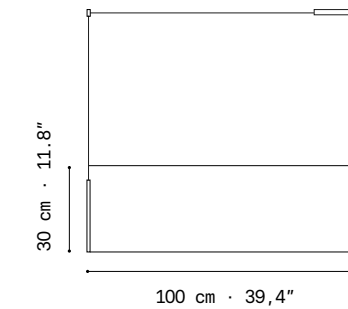

Depth · Profundidad
3 cm | 1,18"

LIGHT SOURCE Built-in LED strip
FUENTE DE LUZ Tira LED integrada

230 V | 50 Hz 20W | 2700K | 3704lm built-in:
directional light 3224lm
decorative light 480lm
Dimmable TRIAC

120 V | 60 Hz 20W | 2700K | 3704lm built-in:
directional light 3224lm
decorative light 480lm
Dimmable 0-10V

NET WEIGHT 2,2 kg | 4,8 lb
PESO NETO

PACKAGING 111x32x26 cm | 43,7x12,6x10,2"
EMBALAJE 3,1 kg | 6,8 lb

NB04_120

LED

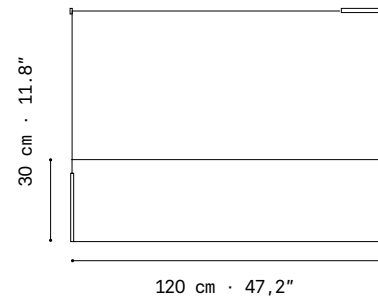

Depth · Profundidad
3 cm | 1,18"

LIGHT SOURCE Built-in LED strip
FUENTE DE LUZ Tira LED integrada

230 V | 50 Hz 33W | 2700K | 3867lm built-in:
directional light 3327lm
decorative light 570lm
Dimmer: PHASE CUT

100~277 V | 60 Hz 33W | 2700K | 3867lm built-in:
directional light 3327lm
decorative light 570lm
Dimmer: 0-10V

NET WEIGHT 4,4 kg | 9,7 lb
PESO NETO

PACKAGING 142x45x27 cm | 55,9x17,7x10,6"
EMBALAJE 8,2 kg | 18,1 lb

NB04_160

LED

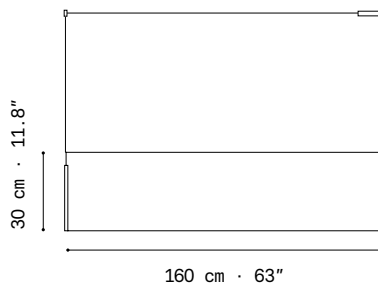

Depth · Profundidad
3 cm | 1,18"

LIGHT SOURCE Built-in LED strip
FUENTE DE LUZ Tira LED integrada

230 V | 50 Hz 42W | 2700K | 4670lm built-in:
directional light 3931lm
decorative light 739lm
Dimmer: PHASE CUT

100~277 V | 60 Hz 42W | 2700K | 4670lm built-in:
directional light 3931lm
decorative light 739lm
Dimmer: 0-10V

NET WEIGHT 7 kg | 15,4 lb
PESO NETO

PACKAGING 180x45x27 cm | 70,8x17,7x10,6"
EMBALAJE 11,3 kg | 24,9 lb

Nevo

Arturo Álvarez, 2007

p. 40

MATERIALS Painted stainless steel
MATERIALES Acero inoxidable pintado

Steel gloss nickel-plated and stainless steel
Acero níquel-satinado y acero inoxidable

FINISHES White · Blanco (BL)
ACABADOS Beige · Beige (BE)

Grey · Gris (G)

Taupe · Topo (T)

Custom · Personalizado (CC)

CABLE Transparent
Transparente

Standard: 150 cm | 59,1"
120 V: 200 cm | 78,7"

Lenght/Largo customizable

CANOPY Steel painted in white
FLORÓN Acero pintado en blanco

NEO4-1
230V: Ø8cm | 3,1"
120V: Ø12cm | 4,7"

CANOPY Steel painted in white
FLORÓN Acero pintado en blanco

NEO4|NEO4G
230V: Ø12cm | 4,7"
120V: Ø12cm | 4,7"

CANOPY Steel painted in white
FLORÓN Acero pintado en blanco

230V: Ø12cm | 4,7"
120V: Ø12cm | 4,7"

DIFFUSER Inside diffuser
DIFUSOR Difusor interno

(LED)

NEO4-1

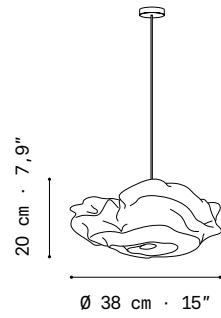

LIGHT SOURCE Recommended bulbs
FUENTE DE LUZ Bombillas recomendadas

230 V | 50 Hz (E14 LED Vintage - Max. 2x7 W)

120 V | 60 Hz (E12 LED - Max. 2x7 W)

NET WEIGHT 1,2 kg | 2,6 lb
PESO NETO

PACKAGING 36x36x31 cm | 14,2x14,2x12,2"
EMBALAJE 2,3 kg | 5 lb

NEO04-1-LD

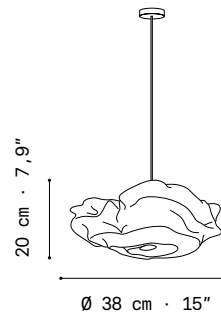

LIGHT SOURCE Light source built in
FUENTE DE LUZ Fuente de luz incluida

230 V | 50 Hz (12W | 2700K | 1151lm built in upon request 3000K 1243lm Dimmer: PHASE CUT/ upon request DALI/ Switch DIM)

100-277 V | 60 Hz (12W | 2700K | 1153lm built in upon request 3000K 1655lm Dimmer: PHASE CONTROL & 0-10V (only 120Vac TRIAC Dimmers))

NET WEIGHT 1,9 kg | 4,2 lb
PESO NETO

PACKAGING 36x36x31 cm | 14,2x14,2x12,2"
EMBALAJE 2,6 kg | 5,1 lb

NEO4

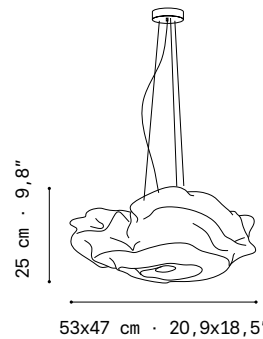

LIGHT SOURCE Recommended bulbs
FUENTE DE LUZ Bombillas recomendadas

230 V | 50 Hz (E27 LED Vintage - Max. 3x8 W)

120 V | 60 Hz (E26 LED - Max. 3x8 W)

NET WEIGHT 3,1 kg | 6,8 lb
PESO NETO

PACKAGING 60x60x33 cm | 23,6x23,6x13"
EMBALAJE 5 kg | 11 lb

NEO4G

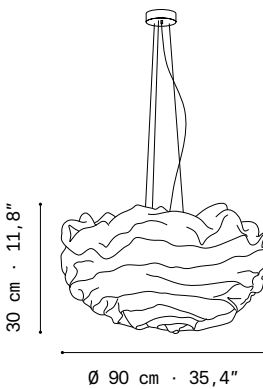

LIGHT SOURCE Recommended bulbs
FUENTE DE LUZ Bombillas recomendadas

230 V | 50 Hz (E27 LED Vintage - Max. 4x12 W)

120 V | 60 Hz (E26 LED - Max. 4x12 W)

NET WEIGHT 5,6 kg | 12,3 lb
PESO NETO

PACKAGING 84x84x38 cm | 33x33x15"
EMBALAJE 9,4kg | 20,7lb

Oon

Arturo Álvarez, 2017

p. 40

MATERIALS Painted stainless steel
MATERIALES Acero inoxidable pintado

Stainless steel
Acero inoxidable

FINISHES White · Blanco (BL)
ACABADOS Beige · Beige (BE)

Grey · Gris (G)

Taupe · Topo (T)

Black · Negro (N)

Custom · Personalizado (CC)

CABLE Transparent or black
Transparente o negro

Standard: 150 cm | 59,1"
120 V: 200 cm | 78,7"

Lenght/Largo customizable

CANOPY Steel gloss nickel-plated
FLORÓN Acero níquel-satinado

230V: Ø8cm | 3,1"
120V: Ø12cm | 4,7"

CANOPY Steel gloss nickel-plated
FLORÓN Acero níquel-satinado

230V: Ø12cm | 4,7"
120V: Ø12cm | 4,7"

DIFFUSER Bottom diffuser
DIFUSOR Difusor inferior

(LED)

ONO4-Mini

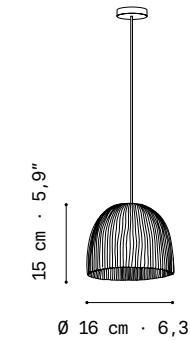

LIGHT SOURCE Recommended bulbs
FUENTE DE LUZ Bombillas recomendadas

230 V | 50 Hz (E14 LED Vintage - Max. 1x4 W)

120 V | 60 Hz (E12 LED - Max. 1x4 W)

NET WEIGHT 0,4 kg | 0,9 lb
PESO NETO

PACKAGING 21x21x22 cm | 8,3x8,3x8,7"
EMBALAJE 1 kg | 2,2 lb

ONO4-Mini-LD

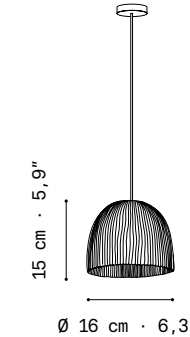

LIGHT SOURCE Light source built in
FUENTE DE LUZ Fuente de luz incluida

230 V | 50 Hz (8W | 2700K | 960lm built in upon request 3000K 1067lm Dimmer: PHASE CUT)

100-277 V | 60 Hz (8W | 2700K | 960lm built in upon request 3000K 1067lm Dimmer: PHASE CONTROL & 0-10V (only 120Vac TRIAC Dimmers))

NET WEIGHT 1 kg | 2,2 lb
PESO NETO

PACKAGING 21x21x22 cm | 8,3x8,3x8,7"
EMBALAJE 1,6 kg | 3,6 lb

ONO4-1

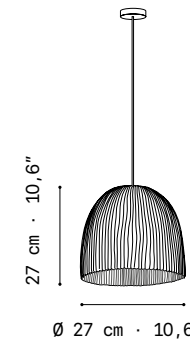

LIGHT SOURCE Recommended bulbs
FUENTE DE LUZ Bombillas recomendadas

230 V | 50 Hz (E27 LED Vintage - Max. 1x12 W)

120 V | 60 Hz (E26 LED - Max. 1x12 W)

NET WEIGHT 0,8 kg | 1,8 lb
PESO NETO

PACKAGING 36x36x31 cm | 14,2x14,2x12,2"
EMBALAJE 1,2 kg | 2,7 lb

ONO4-1-LD

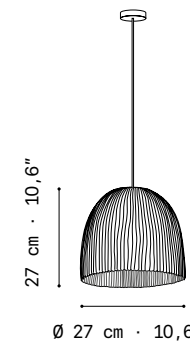

LIGHT SOURCE Light source built in
FUENTE DE LUZ Fuente de luz incluida

230 V | 50 Hz (8W | 2700K | 960lm built in upon request 3000K 1067lm Dimmer: PHASE CUT upon request DALI / Switch DIM)

100-277 V | 60 Hz (8W | 2700K | 960lm built in upon request 3000K 1067lm Dimmer: PHASE CONTROL & 0-10V (only 120Vac TRIAC Dimmers))

NET WEIGHT 1 kg | 2,2 lb
PESO NETO

PACKAGING 36x36x31 cm | 14,2x14,2x12,2"
EMBALAJE 1,6 kg | 3,6 lb

Onn

Arturo Álvarez, 2017

p. 40

MATERIALS Painted stainless steel
MATERIALES Acero inoxidable pintado

Stainless steel
Acero inoxidable

FINISHES White · Blanco (BL)
ACABADOS

Beige · Beige (BE)

Grey · Gris (G)

Taupe · Topo (T)

Black · Negro (N)

Custom · Personalizado (CC)

CABLE Transparent or black
Transparente o negro
Standard: 150 cm | 59,1"
120 V: 200 cm | 78,7"

Length/Largo customizable

CANOPY Steel gloss nickel-plated
FLORÓN Acero niquel-satinado
230V: Ø8cm | 3,1"
120V: Ø12cm | 4,7"

CANOPY Steel gloss nickel-plated
FLORÓN Acero niquel-satinado
230V: Ø12cm | 4,7"
120V: Ø12cm | 4,7"

DIFFUSER Bottom diffuser
DIFUSOR Difusor inferior

ON04

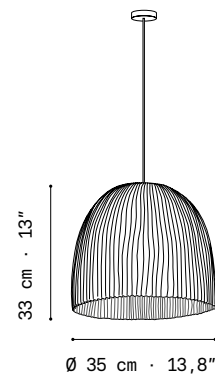

LIGHT SOURCE Recommended bulbs
FUENTE DE LUZ Bombillas recomendadas

230 V | 50 Hz (E27 LED Vintage- Max. 1x12 W)

120 V | 60 Hz (E26 LED - Max. 1x12 W)

NET WEIGHT 1,4 kg | 3,1 lb
PESO NETO

PACKAGING 44x44x40 cm | 17,3x17,3x15,7"
EMBALAJE 3 kg | 6,6 lb

ON04-LD

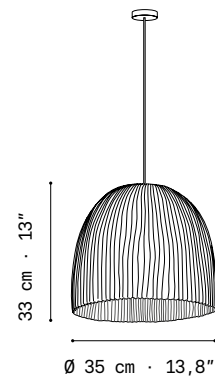

LIGHT SOURCE Light source built in
FUENTE DE LUZ Fuente de luz incluida

230 V | 50 Hz (17W | 2700K | 1645lm built in upon request 3000K 1776lm Dimmer: PHASE CUT upon request DALI/ Switch DIM)

100~277 V | 60 Hz (17W | 2700K | 1645lm built in upon request 3000K 1776lm Dimmer: PHASE CONTROL & 0-10V (only 120Vac TRIAC Dimmers))

NET WEIGHT 2 kg | 4,4 lb
PESO NETO

PACKAGING 44x44x40 cm | 17,3x17,3x15,7"
EMBALAJE 3,8 kg | 8,4 lb

ON04G

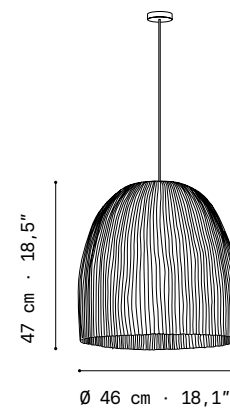

LIGHT SOURCE Recommended bulbs
FUENTE DE LUZ Bombillas recomendadas

230 V | 50 Hz (E27 LED Vintage- Max. 3x12 W)

120 V | 60 Hz (E26 LED - Max. 3x12 W)

NET WEIGHT 2,3 kg | 5,1 lb
PESO NETO

PACKAGING 51x51x53 cm | 20x20x20,9"
EMBALAJE 4,8 kg | 10,6 lb

ON04G-LD

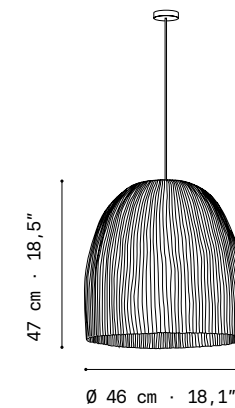

LIGHT SOURCE Light source built in
FUENTE DE LUZ Fuente de luz incluida

230 V | 50 Hz (17W | 2700K | 1645lm built in upon request 3000K 1776lm Dimmer: PHASE CUT upon request DALI/ Switch DIM)

100~277 V | 60 Hz (17W | 2700K | 1645lm built in upon request 3000K 1776lm Dimmer: PHASE CONTROL & 0-10V (only 120Vac TRIAC Dimmers))

NET WEIGHT 3,4 kg | 7,5 lb
PESO NETO

PACKAGING 51x51x53 cm | 20x20x20,9"
EMBALAJE 5,6 kg | 12,3 lb

ON04XL

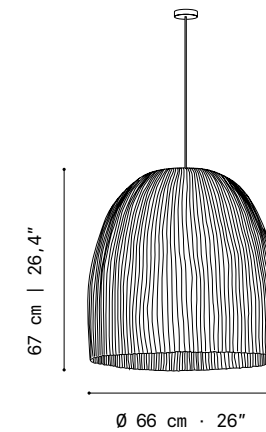

LIGHT SOURCE Recommended bulbs
FUENTE DE LUZ Bombillas recomendadas

230 V | 50 Hz (E14 LED Vintage- Max. 3x12 W)

120 V | 60 Hz (E12 LED - Max. 3x12 W)

NET WEIGHT 5 kg | 11 lb
PESO NETO

PACKAGING 71x71x75 cm | 28x28x29,5"
EMBALAJE 6,6 kg | 14,5 lb

ON04XL-LD

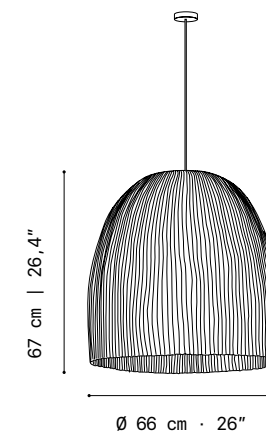

LIGHT SOURCE Light source built in
FUENTE DE LUZ Fuente de luz incluida

230 V | 50 Hz (17W | 2700K | 1645lm built in upon request 3000K 1776lm Dimmer: PHASE CUT upon request DALI/ Switch DIM)

100~277 V | 60 Hz (17W | 2700K | 1645lm built in upon request 3000K 1776lm Dimmer: PHASE CONTROL & 0-10V (only 120Vac TRIAC Dimmers))

NET WEIGHT 5,5 kg | 12,2 lb
PESO NETO

PACKAGING 71x71x75 cm | 28x28x29,5"
EMBALAJE 7,1 kg | 15,1 lb

Parga

Cenlitros, 2023

p. 40

MATERIALS
MATERIALES

Stone
Piedra

Painted stainless steel
Acero inoxidable pintado

FINISHES
ACABADOS

Natural color
Color natural

Black · Negro

CABLE

Black · Negro

Standard: 150 cm | 59,1"
120 V: 200 cm | 78,7"

Lenght/Largo customizable

CANOPY
FLORÓN

Steel painted in matt black
Acero pintado en negro mate

230V: Ø12cm | 4,7"
120V: Ø12cm | 4,7"

DIFFUSER
DIFUSOR

Bottom diffuser
Difusor inferior

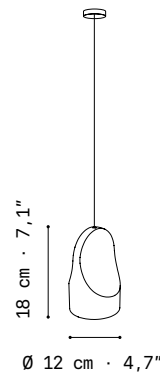

PA104



LIGHT SOURCE
FUENTE DE LUZ

Light source built in
Fuente de luz incluida

230 V | 50 Hz

6W | 2700K | 840lm built in
upon request 3000K 947lm
Dimmer: PHASE CUT
upon request DALI/ Switch DIM

100~277 V |
60 Hz

6W | 2700K | 840lm built in
upon request 3000K 947lm
Dimmer: PHASE CONTROL & 0-10V
(only 120Vac TRIAC Dimmers)

NET WEIGHT
PESO NETO

2,6 kg | 5,7 lb

PACKAGING
EMBALAJE

36x26x19 cm | 14,2x10,2x7,5"
2,9 kg | 6,4 lb

PA204

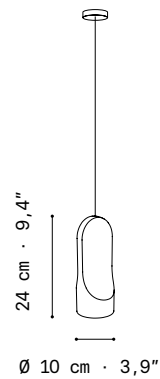

LIGHT SOURCE
FUENTE DE LUZ

Light source built in
Fuente de luz incluida

230 V | 50 Hz

6W | 2700K | 840lm built in
upon request 3000K 947lm
Dimmer: PHASE CUT
upon request DALI/ Switch DIM

100~277 V |
60 Hz

6W | 2700K | 840lm built in
upon request 3000K 947lm
Dimmer: PHASE CONTROL & 0-10V
(only 120Vac TRIAC Dimmers)

NET WEIGHT
PESO NETO

2,2 kg | 4,8 lb

PACKAGING
EMBALAJE

36x26x19 cm | 14,2x10,2x7,5"
2,5 kg | 5,5 lb

PA304

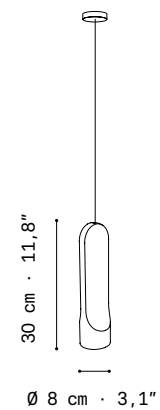

LIGHT SOURCE
FUENTE DE LUZ

Light source built in
Fuente de luz incluida

230 V | 50 Hz

6W | 2700K | 840lm built in
upon request 3000K 947lm
Dimmer: PHASE CUT
upon request DALI/ Switch DIM

100~277 V |
60 Hz

6W | 2700K | 840lm built in
upon request 3000K 947lm
Dimmer: PHASE CONTROL & 0-10V
(only 120Vac TRIAC Dimmers)

NET WEIGHT
PESO NETO

2 kg | 4,4 lb

PACKAGING
EMBALAJE

36x26x19 cm | 14,2x10,2x7,5"
2,3 kg | 5,1 lb

Parga ceramic

Cenlitros, 2025

p. 40

MATERIALS
MATERIALES

Ceramic
Cerámica

Painted stainless steel
Acero inoxidable pintado

FINISHES
ACABADOS

Whyte · Blanco

Black · Negro

Burgundy · Borgoña

CABLE

Black · Negro

Standard: 150 cm | 59,1"
120 V: 200 cm | 78,7"

Lenght/Largo customizable

CANOPY
FLORÓN

Steel painted in matt black
Acero pintado en negro mate

230V: Ø8cm | 3,1"
120V: Ø12cm | 4,7"

CANOPY
FLORÓN

Steel painted in matt black
Acero pintado en negro mate

230V: Ø12cm | 4,7"
120V: Ø12cm | 4,7"

DIFFUSER
DIFUSOR

Bottom diffuser
Difusor inferior

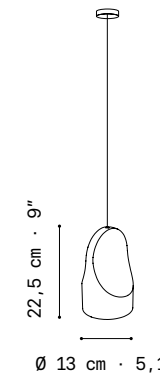

PAC104



LIGHT SOURCE
FUENTE DE LUZ

Recommended bulbs
Bombillas recomendadas

230 V | 50 Hz

E27 LED Vintage-
Max. 1x12 W

120 V | 60 Hz

E26 LED - Max. 1x12 W

NET WEIGHT
PESO NETO

1,1 kg | 2,4 lb

PACKAGING
EMBALAJE

36x26x19 cm | 14,2x10,2x7,5"
1,7 kg | 3,7 lb

PAC104-LD

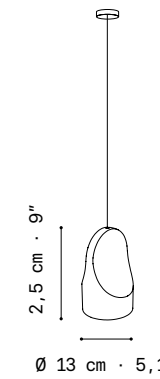

LIGHT SOURCE
FUENTE DE LUZ

Light source built in
Fuente de luz incluida

230 V | 50 Hz

6W | 2700K | 840lm built in
upon request 3000K 947lm
Dimmer: PHASE CUT
upon request DALI/ Switch DIM

100~277 V |
60 Hz

6W | 2700K | 840lm built in
upon request 3000K 947lm
Dimmer: PHASE CONTROL & 0-10V
(only 120Vac TRIAC Dimmers)

NET WEIGHT
PESO NETO

1,1 kg | 2,4 lb

PACKAGING
EMBALAJE

36x26x19 cm | 14,2x10,2x7,5"
1,7 kg | 3,7 lb

PAC204

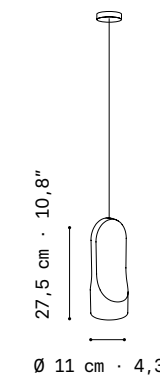

LIGHT SOURCE
FUENTE DE LUZ

Recommended bulbs
Bombillas recomendadas

230 V | 50 Hz

E27 LED Vintage-
Max. 1x12 W

120 V | 60 Hz

E26 LED - Max. 1x12 W

NET WEIGHT
PESO NETO

1 kg | 2,2 lb

PACKAGING
EMBALAJE

36x26x19 cm | 14,2x10,2x7,5"
1,6 kg | 3,5 lb

PAC204-LD

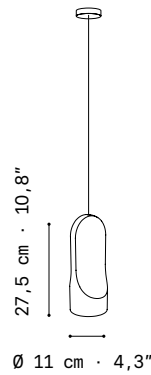

LIGHT SOURCE Light source built in
FUENTE DE LUZ Fuente de luz incluida

230 V | 50 Hz 6W | 2700K | 840lm built in
upon request 3000K 947lm
Dimmer: PHASE CUT
upon request DALI/ Switch DIM

100~277 V | 60 Hz 6W | 2700K | 840lm built in
upon request 3000K 947lm
Dimmer: PHASE CONTROL & 0-10V
(only 120Vac TRIAC Dimmers)

NET WEIGHT 1 kg | 2,2 lb
PESO NETO

PACKAGING 36x26x19 cm | 14,2x10,2x7,5"
EMBALAJE 1,6 kg | 3,5 lb

PAC304

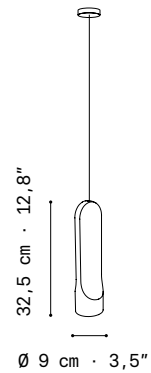

LIGHT SOURCE Recommended bulbs
FUENTE DE LUZ Bombillas recomendadas

230 V | 50 Hz E27 LED Vintage-
Max. 1x12 W

120 V | 60 Hz E26 LED - Max. 1x12 W

NET WEIGHT 0,9 kg | 2 lb
PESO NETO

PACKAGING 36x26x19 cm | 14,2x10,2x7,5"
EMBALAJE 1,5 kg | 3,3 lb

PAC304-LD

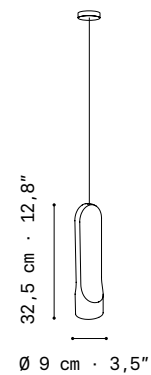

LIGHT SOURCE Light source built in
FUENTE DE LUZ Fuente de luz incluida

230 V | 50 Hz 6W | 2700K | 840lm built in
upon request 3000K 947lm
Dimmer: PHASE CUT
upon request DALI/ Switch DIM

100~277 V | 60 Hz 6W | 2700K | 840lm built in
upon request 3000K 947lm
Dimmer: PHASE CONTROL & 0-10V
(only 120Vac TRIAC Dimmers)

NET WEIGHT 0,9 kg | 2 lb
PESO NETO

PACKAGING 36x26x19 cm | 14,2x10,2x7,5"
EMBALAJE 1,5 kg | 3,3 lb

Pili

Arturo Álvarez, 2017

p. 40

MATERIALS Painted stainless steel thread
MATERIALES Hilo de acero inoxidable
pintado

FINISHES White · Blanco

CABLE Transparent
Transparente
Standard: 150 cm | 59,1"
120 V: 200 cm | 78,7"
Length/Largo customizable

CANOPY Steel gloss nickel- plated
FLORÓN Acero niquel-satinado
230V: Ø8cm | 3,1"
120V: Ø12cm | 4,7"

PL04-Mini

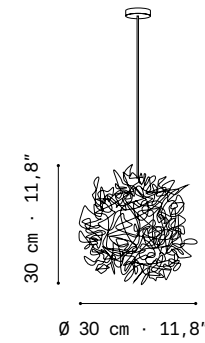

LIGHT SOURCE Recommended bulbs
FUENTE DE LUZ Bombillas recomendadas

230 V | 50 Hz E27 LED Vintage-
Max. 1x12 W

120 V | 60 Hz E26 LED - Max. 1x12 W

NET WEIGHT 0,8 kg | 1,8 lb
PESO NETO

PACKAGING 36x36x30 cm | 14,2x14,2x11,8"
EMBALAJE 1,5 kg | 3,3 lb

PL04

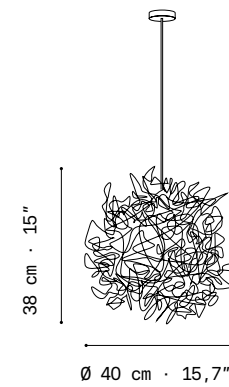

LIGHT SOURCE Recommended bulbs
FUENTE DE LUZ Bombillas recomendadas

230 V | 50 Hz E27 LED Vintage-
Max. 1x12 W

120 V | 60 Hz E26 LED - Max. 1x12 W

NET WEIGHT 0,8 kg | 1,8 lb
PESO NETO

PACKAGING 44x44x40 cm | 17,3x17,3x15,7"
EMBALAJE 2,5 kg | 5,5 lb

Tati

Arturo Álvarez, 2011

p. 40

MATERIALS Painted stainless steel
MATERIALES Acero inoxidable pintado

Steel gloss nickel- plated and stainless steel
Acero níquel-satinado y acero inoxidable

FINISHES White · Blanco (BL)
ACABADOS

Beige · Beige (BE)

Grey · Gris (G)

Taupe · Topo (T)

Custom · Personalizado (CC)

CABLE Transparent or black
Transparente o negro
Standard: 150 cm | 59,1"
120 V: 200 cm | 78,7"

Lenght/Largo customizable

CABLE Transparent or black
Transparente o negro
Standard: 150 cm | 59,1"
120 V: 200 cm | 78,7"

Lenght/Largo customizable

CANOPY Steel painted in white
FLORÓN Acero pintado en blanco
230V: Ø12cm | 4,7"
120V: Ø12cm | 4,7"

TAO4-1

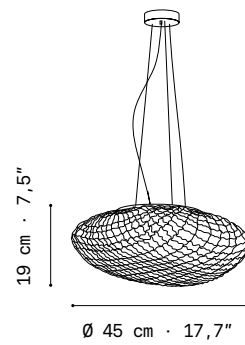

TAO4-1-LD

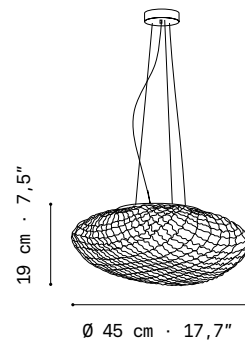

TAO4

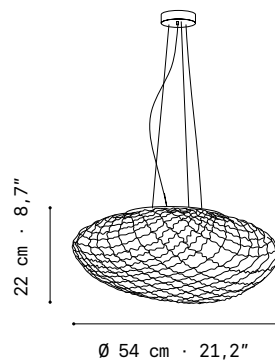

TAO4G

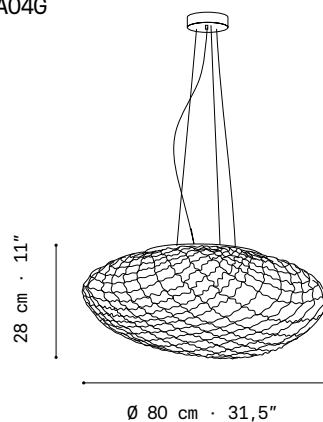

LIGHT SOURCE Recommended bulbs
FUENTE DE LUZ Bombillas recomendadas

230 V | 50 Hz E27 LED Vintage- Max. 1x8 W

120 V | 60 Hz E26 LED - Max. 1x8 W

NET WEIGHT 2 kg | 4,4 lb
PESO NETO

PACKAGING 56x46x37 cm | 22x18x14,6"
EMBALAJE 3 kg | 6,6 lb



LIGHT SOURCE Light source built in
FUENTE DE LUZ Fuente de luz incluida

230 V | 50 Hz 17W | 2700K | 1645lm built in upon request 3000K 1776lm Dimmer: PHASE CUT/ upon request DALI/ Switch DIM

100-277 V | 60 Hz 17W | 2700K | 1645lm built in upon request 3000K 1776lm Dimmer: PHASE CONTROL & 0-10V (only 120Vac TRIAC Dimmers)

NET WEIGHT 2,2 kg | 4,8 lb
PESO NETO

PACKAGING 56x46x37 cm | 22x18x14,6"
EMBALAJE 3,5 kg | 7,1 lb



LIGHT SOURCE Recommended bulbs
FUENTE DE LUZ Bombillas recomendadas

230 V | 50 Hz E27 LED Vintage- Max. 3x12 W

120 V | 60 Hz E26 LED - Max. 3x12 W

NET WEIGHT 3,1 kg | 6,8 lb
PESO NETO

PACKAGING 60x60x33 cm | 23,6x23,6x13"
EMBALAJE 4 kg | 8,8 lb



LIGHT SOURCE Recommended bulbs
FUENTE DE LUZ Bombillas recomendadas

230 V | 50 Hz E27 LED Vintage- Max. 4x12 W

120 V | 60 Hz E26 LED - Max. 4x12 W

NET WEIGHT 4,3 kg | 9,5 lb
PESO NETO

PACKAGING 84x84x38 cm | 33x33x15"
EMBALAJE 10,2 kg | 22,5 lb

Tempo Andante

Arturo Álvarez, 2016

p. 40

MATERIALS Painted stainless steel
MATERIALES Acero inoxidable pintado

FINISHES White · Blanco (BL)
ACABADOS

Beige · Beige (BE)

Grey · Gris (G)

Taupe · Topo (T)

Black · Negro (N)

Custom · Personalizado (CC)

CABLE Transparent or black
Transparente o negro
Standard: 150 cm | 59,1"
120 V: 200 cm | 78,7"

Lenght/Largo customizable

CABLE Black waterproof neoprene cable H05RN-F
Cable de neopreno negro resistente al agua H05RN-F

Standard: 150cm | 59,1"
Lenght/largo customizable

CANOPY Steel gloss nickel- plated
FLORÓN Acero níquel-satinado
230V: Ø8cm | 3,1"
120V: Ø12cm | 4,7"

CANOPY Steel gloss nickel- plated
FLORÓN Acero níquel-satinado
230V: Ø12cm | 4,7"
120V: Ø12cm | 4,7"

CANOPY Steel and stainless steel coated with epoxy paint in black
FLORÓN Acero y acero inoxidable pintado en negro
Ø12cm | 4,7"

STANDARDS TESTED EN 60598
NORMAS ENSAYADAS EN 60529
Degree IP | Grado IP IP64

DIFFUSER Bottom diffuser
DIFUSOR Difusor inferior

TEAN04

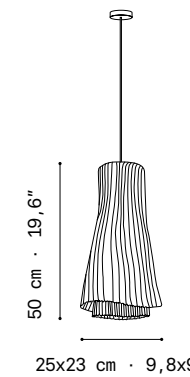

TEAN04-LD

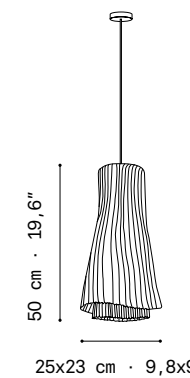

TEAN04-EXT

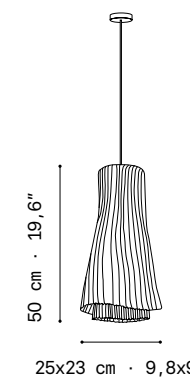

LIGHT SOURCE Recommended bulbs
FUENTE DE LUZ Bombillas recomendadas

230 V | 50 Hz E27 LED Vintage- Max. 1x12 W

120 V | 60 Hz E26 LED - Max. 1x12 W

NET WEIGHT 1,6 kg | 3,5 lb
PESO NETO

PACKAGING 65x32x23 cm | 25,6x12,6x9,1"
EMBALAJE 1,8 kg | 4 lb



LIGHT SOURCE Light source built in
FUENTE DE LUZ Fuente de luz incluida

230 V | 50 Hz 17W | 2700K | 1645lm built in upon request 3000K 1776lm Dimmer: PHASE CUT upon request DALI/ Switch DIM

100-277 V | 60 Hz 17W | 2700K | 1645lm built in upon request 3000K 1776lm Dimmer: PHASE CONTROL & 0-10V (only 120Vac TRIAC Dimmers)

NET WEIGHT 2,1 kg | 4,6 lb
PESO NETO

PACKAGING 65x32x23 cm | 25,6x12,6x9,1"
EMBALAJE 2,4 kg | 5,5 lb



LIGHT SOURCE Recommended bulbs
FUENTE DE LUZ Bombillas recomendadas

220-240 V | 50/60 Hz E27 LED Vintage- Max. 1x15 W BULB A60 G125 G95 ST64

Only LED BULB suitable for contact with water and use in humid condition
Solamente Bombillas LED aptas para el contacto con el agua y utilización en condiciones de humedad not available in 120V

NET WEIGHT 1,6 kg | 3,5 lb
PESO NETO

PACKAGING 65x32x23 cm | 25,6x12,6x9,1"
EMBALAJE 1,8 kg | 4 lb

Tempo Vivace

Arturo Álvarez, 2016

p. 40

MATERIALS Painted stainless steel
MATERIALES Acero inoxidable pintado

FINISHES White · Blanco (BL)
ACABADOS Beige · Beige (BE)

Grey · Gris (G)

Taupe · Topo (T)

Black · Negro (N)

Custom · Personalizado (CC)

CABLE Transparent or black
Transparente o negro
Standard: 150 cm | 59,1"
120 V: 200 cm | 78,7"

Lenght/Largo customizable

CABLE (EXT) Black waterproof neoprene cable H05RN-F
Cable de neopreno negro resistente al agua H05RN-F

Standard: 150cm | 59,1"
Lenght/largo customizable

CANOPY Steel gloss nickel- plated
FLORÓN Acero níquel-satinado
230V: Ø8cm | 3,1"
120V: Ø12cm | 4,7"

CANOPY (LED) Steel gloss nickel- plated
FLORÓN Acero níquel-satinado
230V: Ø12cm | 4,7"
120V: Ø12cm | 4,7"

CANOPY (EXT) Steel and stainless steel coated with epoxy paint in black
FLORÓN Acero y acero inoxidable pintado en negro
Ø12cm | 4,7"

STANDARDS EN 60598
TESTED (EXT) EN 60529
NORMAS Degree IP | Grado IP
ENSAYADAS IP64

DIFFUSER Bottom diffuser
DIFUSOR (LED) Difusor inferior

TEVIO4-Mini

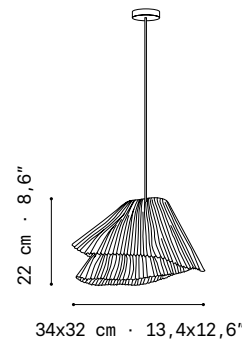

LIGHT SOURCE Recommended bulbs
FUENTE DE LUZ Bombillas recomendadas

230 V | 50 Hz (E14 LED Vintage- Max. 1x4 W)

120 V | 60 Hz (E12 LED - Max. 1x4 W)

NET WEIGHT 1 kg | 2,2 lb
PESO NETO

PACKAGING 36x36x31 cm | 14,2x14,2x12,2"
EMBALAJE 1,5 kg | 3,3 lb

TEVIO4-Mini-LD

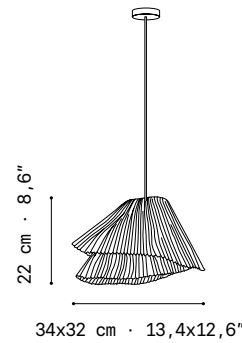

LIGHT SOURCE Light source built in
FUENTE DE LUZ Fuente de luz incluida

230 V | 50 Hz (8W | 2700K | 960lm built in upon request 3000K 1067lm Dimmer: PHASE CUT)

100~277 V | 60 Hz (8W | 2700K | 960lm built in upon request 3000K 1067lm Dimmer: PHASE CONTROL & 0-10V (only 120Vac TRIAC Dimmers))

NET WEIGHT 1,3 kg | 2,9 lb
PESO NETO

PACKAGING 36x36x31 cm | 14,2x14,2x12,2"
EMBALAJE 1,6 kg | 3,5 lb

TEVIO4

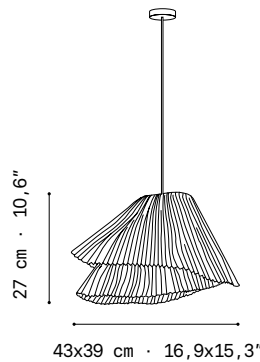

LIGHT SOURCE Recommended bulbs
FUENTE DE LUZ Bombillas recomendadas

230 V | 50 Hz (E27 LED Vintage- Max. 1x12 W)

120 V | 60 Hz (E26 LED - Max. 1x12 W)

NET WEIGHT 1,6 kg | 3,5 lb
PESO NETO

PACKAGING 44x44x40 cm | 17,3x17,3x15,7"
EMBALAJE 2,2 kg | 4,8 lb

TEVIO4-LD

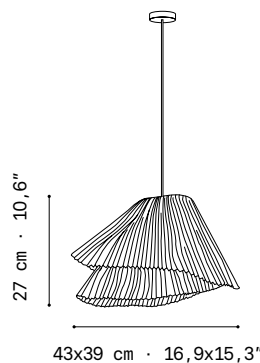

LIGHT SOURCE Light source built in
FUENTE DE LUZ Fuente de luz incluida

230 V | 50 Hz (8W | 2700K | 960lm built in upon request 3000K 1067lm Dimmer: PHASE CUT upon request DALI / Switch DIM)

100~277 V | 60 Hz (8W | 2700K | 960lm built in upon request 3000K 1067lm Dimmer: PHASE CONTROL & 0-10V (only 120Vac TRIAC Dimmers))

NET WEIGHT 2,2 kg | 4,6 lb
PESO NETO

PACKAGING 44x44x40 cm | 17,3x17,3x15,7"
EMBALAJE 3 kg | 6,6 lb

TEVIO4-EXT

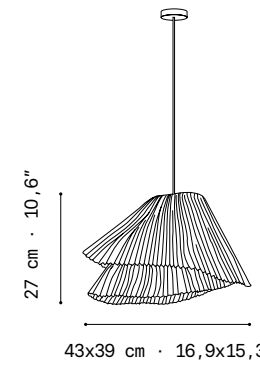

LIGHT SOURCE Recommended bulbs
FUENTE DE LUZ Bombillas recomendadas

220-240 V | 50/60 Hz (E27 LED Vintage- Max. 1x15 W BULB A60 G125 G95 ST64)

Only LED BULB suitable for contact with water and use in humid condition
Solamente Bombillas LED aptas para el contacto con el agua y utilización en condiciones de humedad not available in 120V

NET WEIGHT 2,2 kg | 4,6 lb
PESO NETO

PACKAGING 44x44x40 cm | 17,3x17,3x15,7"
EMBALAJE 3 kg | 6,6 lb

TEVIO4G

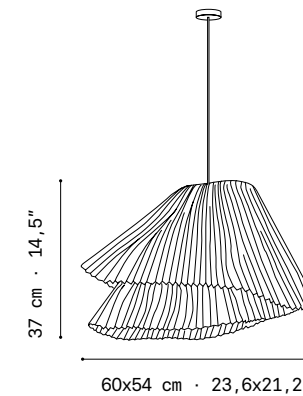

LIGHT SOURCE Recommended bulbs
FUENTE DE LUZ Bombillas recomendadas

230 V | 50 Hz (E27 LED Vintage- Max. 1x12 W)

120 V | 60 Hz (E26 LED - Max. 1x12 W)

NET WEIGHT 2,1 kg | 4,4 lb
PESO NETO

PACKAGING 72x72x43 cm | 28,3x28,3x17"
EMBALAJE 2,8 kg | 6,2 lb

TEVIO4G-LD

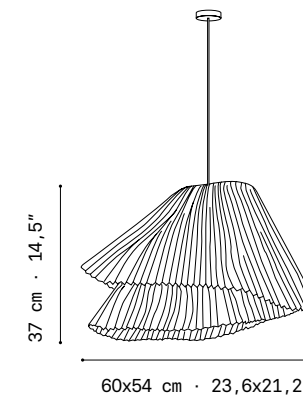

LIGHT SOURCE Light source built in
FUENTE DE LUZ Fuente de luz incluida

230 V | 50 Hz (17W | 2700K | 1645lm built in upon request 3000K 1776lm Dimmer: PHASE CUT upon request DALI/ Switch DIM)

100~277 V | 60 Hz (17W | 2700K | 1645lm built in upon request 3000K 1776lm Dimmer: PHASE CONTROL & 0-10V (only 120Vac TRIAC Dimmers))

NET WEIGHT 2,2 kg | 4,6 lb
PESO NETO

PACKAGING 72x72x43 cm | 28,3x28,3x17"
EMBALAJE 3 kg | 6,6 lb

Ura

Arturo Álvarez, 2017

p. 40

MATERIALS Painted stainless steel
MATERIALES Acero inoxidable pintado

Stainless steel
Acero inoxidable

FINISHES White · Blanco (BL)
ACABADOS Beige · Beige (BE)

Grey · Gris (G)

Taupe · Topo (T)

Black · Negro (N)

Custom · Personalizado (CC)

CABLE Transparent or black
Transparente o negro
Standard: 150 cm | 59,1"
120 V: 200 cm | 78,7"

Lenght/Largo customizable

CANOPY Steel gloss nickel- plated
FLORÓN Acero níquel-satinado
230V: Ø8cm | 3,1"
120V: Ø12cm | 4,7"

CANOPY Steel gloss nickel- plated
FLORÓN Acero níquel-satinado
230V: Ø12cm | 4,7"
120V: Ø12cm | 4,7"

DIFFUSER Bottom diffuser
DIFUSOR Difusor inferior

UR104

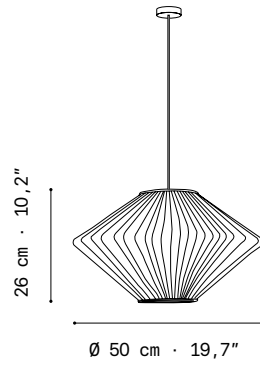

LIGHT SOURCE Recommended bulbs
FUENTE DE LUZ Bombillas recomendadas

230 V | 50 Hz E27 LED Vintage-
Max. 1x12 W

120 V | 60 Hz E26 LED - Max. 1x12 W

NET WEIGHT 1,8 kg | 4 lb
PESO NETO

PACKAGING 60x60x33 cm | 23,6x23,6x13"
EMBALAJE 4,2 kg | 9,2 lb

UR104-LD

LED



LIGHT SOURCE Light source built in
FUENTE DE LUZ Fuente de luz incluida

230 V | 50 Hz 17W | 2700K | 1645lm built in
upon request 3000K 1776lm
Dimmer: PHASE CUT

100-277 V | 60 Hz 17W | 2700K | 1645lm built in
upon request 3000K 1776lm
Dimmer: PHASE CONTROL & 0-10V
(only 120Vac TRIAC Dimmers)

NET WEIGHT 2,3 kg | 5,1 lb
PESO NETO

PACKAGING 60x60x33 cm | 23,6x23,6x13"
EMBALAJE 4,7 kg | 10,4 lb

UR204

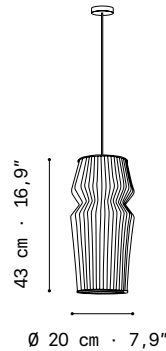

LIGHT SOURCE Recommended bulbs
FUENTE DE LUZ Bombillas recomendadas

230 V | 50 Hz E27 LED Vintage-
Max. 1x12 W

120 V | 60 Hz E26 LED - Max. 1x12 W

NET WEIGHT 1,1 kg | 2,4 lb
PESO NETO

PACKAGING 46x24x26 cm | 18,1x9,4x10,2"
EMBALAJE 1,6 kg | 3,5 lb

UR204-LD

LED



LIGHT SOURCE Light source built in
FUENTE DE LUZ Fuente de luz incluida

230 V | 50 Hz 17W | 2700K | 1645lm built in
upon request 3000K 1776lm
Dimmer: PHASE CUT

100-277 V | 60 Hz 17W | 2700K | 1645lm built in
upon request 3000K 1776lm
Dimmer: PHASE CONTROL & 0-10V
(only 120Vac TRIAC Dimmers)

NET WEIGHT 1,7 kg | 3,7 lb
PESO NETO

PACKAGING 46x24x26 cm | 18,1x9,4x10,2"
EMBALAJE 2,1 kg | 4,6 lb

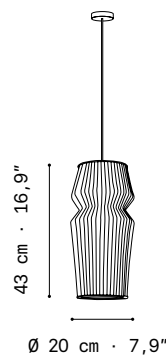

UR304

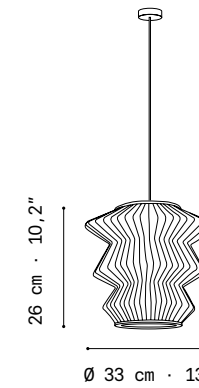

LIGHT SOURCE Recommended bulbs
FUENTE DE LUZ Bombillas recomendadas

230 V | 50 Hz E27 LED Vintage-
Max. 1x12 W

120 V | 60 Hz E26 LED - Max. 1x12 W

NET WEIGHT 1,3 kg | 2,9 lb
PESO NETO

PACKAGING 36x36x31 cm | 14,2x14,2x12,2"
EMBALAJE 1,6 kg | 3,5 lb

URA304-LD

LED



LIGHT SOURCE Light source built in
FUENTE DE LUZ Fuente de luz incluida

230 V | 50 Hz 17W | 2700K | 1645lm built in
upon request 3000K 1776lm
Dimmer: PHASE CUT
upon request DALI/ Switch DIM

100-277 V | 60 Hz 17W | 2700K | 1645lm built in
upon request 3000K 1776lm
Dimmer: PHASE CONTROL & 0-10V
(only 120Vac TRIAC Dimmers)

NET WEIGHT 1,8 kg | 4 lb
PESO NETO

PACKAGING 36x36x31 cm | 14,2x14,2x12,2"
EMBALAJE 2 kg | 4,4 lb

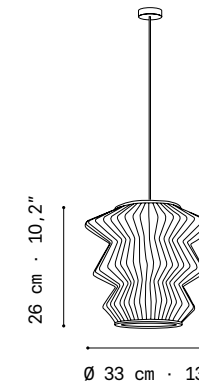

Veiga

Isaac Piñeiro, 2025

p. 40

MATERIALS Colored glass
MATERIALES Vidrio soplado
FINISHES White · Blanco (B)
ACABADOS Cream · Crema (CM)

Grey · Gris (G)

Amethyst · Amatista (AM)

CABLE Black · Negro
Standard: 150 cm | 59,1"
120 V: 200 cm | 78,7"

Lenght/Largo customizable

CANOPY Black · Negro
FLORÓN 230V: Ø8cm | 3,1"
120V: Ø12cm | 4,7"

VAO4

LED



LIGHT SOURCE Light source built in
FUENTE DE LUZ Fuente de luz incluida

230 V | 50 Hz 4 W | 2700K | 350lm built in
upon request 3000K 370lm
Dimmer: PHASE CUT
upon request DALI/ Switch DIM

100-277 V | 60 Hz 4 W | 2700K | 350lm built in
upon request 3000K 370lm
Dimmer: PHASE CONTROL & 0-10V
(only 120Vac TRIAC Dimmers)

NET WEIGHT 1,1 kg | 2,4 lb
PESO NETO

PACKAGING 25x25x28 cm | 9,8x9,8x11"
EMBALAJE 1,6 kg | 3,5 lb

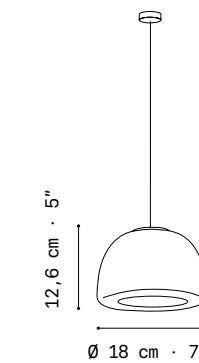

Virginia

Arturo Álvarez, 2016

p. 40

MATERIALS Painted stainless steel
MATERIALES Acero inoxidable pintado

Stainless steel
Acero inoxidable

FINISHES White · Blanco (BL)
ACABADOS

Beige · Beige (BE)

Grey · Gris (G)

Taupe · Topo (T)

Black · Negro (N)

Custom · Personalizado (CC)

CABLE Transparent or black
Transparente o negro
Standard: 150 cm | 59,1"
120 V: 200 cm | 78,7"

Lenght/Largo customizable

CABLE (EXT) Black waterproof neoprene cable H05RN-F
Cable de neopreno negro resistente al agua H05RN-F

Standard: 150cm | 59,1"
Lenght/largo customizable

CANOPY Steel gloss nickel- plated
FLORÓN Acero níquel-satinado
230V: Ø8cm | 3,1"
120V: Ø12cm | 4,7"

CANOPY (LED) Steel gloss nickel- plated
FLORÓN Acero níquel-satinado
230V: Ø12cm | 4,7"
120V: Ø12cm | 4,7"

CANOPY (EXT) Steel and stainless steel coated with epoxy paint in black
FLORÓN Acero y acero inoxidable pintado en negro
Ø12cm | 4,7"

STANDARDS EN 60598
TESTED (EXT) EN 60529
NORMAS Degree IP | Grado IP
ENSAYADAS IP64

DIFFUSER Bottom diffuser
DIFUSOR (LED) Difusor inferior

VGO4A

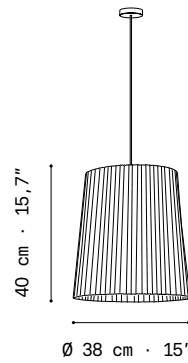

LIGHT SOURCE Recommended bulbs
FUENTE DE LUZ Bombillas recomendadas

230 V | 50 Hz (E27 LED Vintage- Max. 1x12 W)

120 V | 60 Hz (E26 LED - Max. 1x12 W)

NET WEIGHT 3,5 kg | 7,7 lb
PESO NETO

PACKAGING 51x51x53 cm | 20,7x20,7x20,9"
EMBALAJE 4,2 kg | 9,3 lb

VGO4A-LD

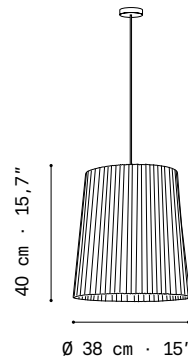

LIGHT SOURCE Light source built in
FUENTE DE LUZ Fuente de luz incluida

230 V | 50 Hz (17W | 2700K | 1645lm built in upon request 3000K 1776lm Dimmer: PHASE CUT/ upon request DALI/ Switch DIM)

100-277 V | 60 Hz (17W | 2700K | 1645lm built in upon request 3000K 1776lm Dimmer: PHASE CONTROL & 0-10V (only 120Vac TRIAC Dimmers))

NET WEIGHT 3,8 kg | 8,4 lb
PESO NETO

PACKAGING 51x51x53 cm | 20,7x20,7x20,9"
EMBALAJE 4,5 kg | 9,9 lb

VGO4A-EXT

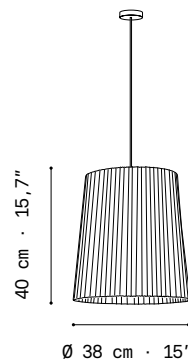

LIGHT SOURCE Recommended bulbs
FUENTE DE LUZ Bombillas recomendadas

220-240 V | 50/60 Hz (E27 LED Vintage- Max. 1x15 W BULB A60 G125 G95 ST64)

(Only LED BULB suitable for contact with water and use in humid condition Solamente Bombillas LED aptas para el contacto con el agua y utilización en condiciones de humedad not available in 120V)

NET WEIGHT 3,5 kg | 7,7 lb
PESO NETO

PACKAGING 51x51x53 cm | 20,7x20,7x20,9"
EMBALAJE 4,2 kg | 9,3 lb

VGO4B

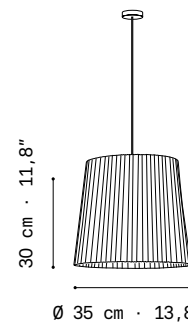

LIGHT SOURCE Recommended bulbs
FUENTE DE LUZ Bombillas recomendadas

230 V | 50 Hz (E27 LED Vintage- Max. 1x12 W)

120 V | 60 Hz (E26 LED - Max. 1x12 W)

NET WEIGHT 3 kg | 6,6 lb
PESO NETO

PACKAGING 44x44x40 cm | 17,3x17,3x15,7"
EMBALAJE 3,7 kg | 8,2 lb

VGO4B-LD

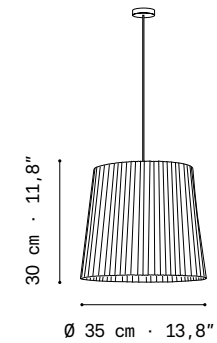

LIGHT SOURCE Light source built in
FUENTE DE LUZ Fuente de luz incluida

230 V | 50 Hz (17W | 2700K | 1645lm built in upon request 3000K 1776lm Dimmer: PHASE CUT upon request DALI/ Switch DIM)

100-277 V | 60 Hz (17W | 2700K | 1645lm built in upon request 3000K 1776lm Dimmer: PHASE CONTROL & 0-10V (only 120Vac TRIAC Dimmers))

NET WEIGHT 3,3 kg | 7,3 lb
PESO NETO

PACKAGING 44x44x40 cm | 17,3x17,3x15,7"
EMBALAJE 4 kg | 8,8 lb

VGO4B-EXT

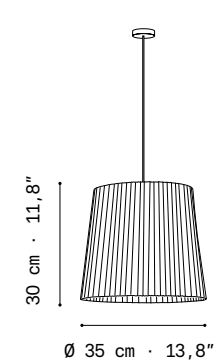

LIGHT SOURCE Recommended bulbs
FUENTE DE LUZ Bombillas recomendadas

220-240 V | 50/60 Hz (E27 LED Vintage- Max. 1x15 W BULB A60 G125 G95 ST64)

(Only LED BULB suitable for contact with water and use in humid condition Solamente Bombillas LED aptas para el contacto con el agua y utilización en condiciones de humedad not available in 120V)

3 kg | 6,6 lb

PACKAGING 44x44x40 cm | 17,3x17,3x15,7"
EMBALAJE 3,7 kg | 8,2 lb

V

Héctor Serrano, 2007

p. 40

MATERIALS Polycarbonate
MATERIALES Policarbonato

FINISHES White · Blanco (BL)
ACABADOS

Black · Negro (N)

Terracotta · Terracota (TE)

Custom · Personalizado (CC)

CABLE Transparent or black
Transparente o negro
Standard: 150 cm | 59,1"
120 V: 200 cm | 78,7"

Lenght/Largo customizable

CANOPY Steel painted in white/black
FLORÓN Acero pintado en blanco/ negro
230V: Ø12cm | 4,7"
120V: Ø12cm | 4,7"

DIFFUSER Glass diffuser
DIFUSOR VV04 Difusor de vidrio

DIFFUSER Acrylic diffuser
DIFUSOR VV04G Difusor acrilico

VV04

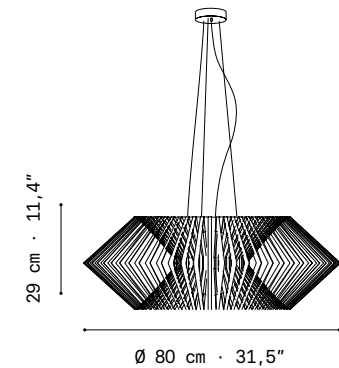

LIGHT SOURCE Recommended bulbs
FUENTE DE LUZ Bombillas recomendadas

230 V | 50 Hz (E27 LED Vintage- Max. 1x8 W)

120 V | 60 Hz (E26 LED - Max. 1x8 W)

NET WEIGHT 5,4 kg | 12 lb
PESO NETO

PACKAGING 84x84x38 cm | 33x33x15"
EMBALAJE 9,6 kg | 21,2 lb

VV04G

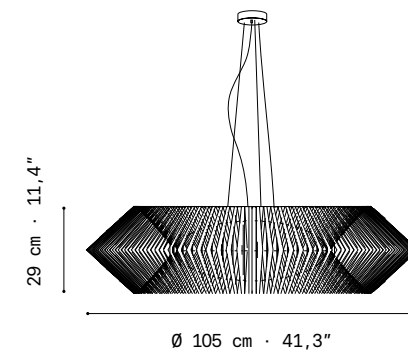

LIGHT SOURCE Recommended bulbs
FUENTE DE LUZ Bombillas recomendadas

230 V | 50 Hz (E27 LED Vintage- Max. 4x8 W)

120 V | 60 Hz (E26 LED - Max. 4x8 W)

NET WEIGHT 12 kg | 26,5 lb
PESO NETO

PACKAGING 110x110x33 cm | 43,3x43,3x13"
EMBALAJE 15 kg | 33 lb

Vento





Arturo Álvarez, 2005

p. 40

MATERIALS
MATERIALES

Glass
Vidrio

FINISHES
ACABADOS

- 02 
- 87 
- 89 
- 90 

Color combination
90+95 

CABLE

Transparent or black
Transparente o negro
Standard: 150 cm | 59,1"
120 V: 200 cm | 78,7"

Length/Largo customizable

CANOPY
FLORÓN

Stainless steel
Acero inoxidable
230V: 13x11cm | 5,1x4,3"
120V: 13x11cm | 5,1x4,3"

DIFFUSER
DIFUSOR

Bottom diffuser
Difusor inferior

VNO4-LD

LED

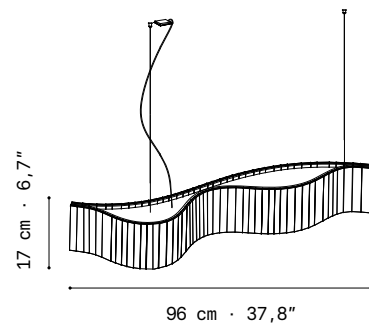

Depth · Profundidad
19 cm | 7,5"

LIGHT SOURCE
FUENTE DE LUZ

Recommended bulbs
Bombillas recomendadas

230 V | 50 Hz  20W | 2700K | 2637 built in
upon request 3000K | 2721lm
Dimmer: DALI/ Switch DIM
upon request PHASE CUT



100-277 V | 60 Hz  20W | 2700K | 2637 built in
upon request 3000K | 2721lm
Dimmer: PHASE CONTROL & 0-10V
(only 120Vac TRIAC Dimmers)

NET WEIGHT
PESO NETO

5,6 kg | 12,3 lb

PACKAGING
EMBALAJE

31x111x26 cm | 12,2x43,7x10,2"
9,8 kg | 21,6 lb

Woods

Héctor Serrano, 2011

p. 40

MATERIALS
MATERIALES

Birch
Abedul

*Height is not adjustable on site
*Altura no ajustable

FINISHES
ACABADOS

Natural color
Color natural 

CABLE

Transparent
Transparente

CANOPY
FLORÓN

Painted steel
Acero pintado
230V: Ø60cm | 23,6"
120V: Ø60cm | 23,6"

DIFFUSER
DIFUSOR

Glass diffuser
Difusor de vidrio

WDO4

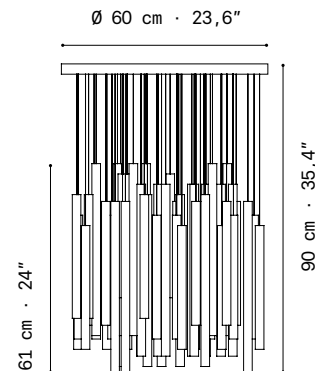

LIGHT SOURCE
FUENTE DE LUZ

Recommended bulbs
Bombillas recomendadas

230 V | 50 Hz  E27 LED Vintage-
Max. 1x12 W

120 V | 60 Hz  E26 LED - Max. 1x12 W

NET WEIGHT
PESO NETO

14,3 kg | 31,5 lb

PACKAGING
EMBALAJE

60x60x33 cm | 23,6x23,6x13"
17 kg | 37,7 lb

Compositions

Composiciones

Agasallo

Héctor Serrano, 2021

p. 40

MATERIALS
MATERIALES

Painted stainless steel
Acero inoxidable pintado

FINISHES
ACABADOS

Stainless steel
Acero inoxidable

White · Blanco 

Beige · Beige 

Grey · Gris 

Taupe · Topo 

Black · Negro 

Custom · Personalizado 

LAMPSHADE
TULIPA

ref. 1xAG104, 1xAG204,
1xAG304, 1xAG404

CABLE

Black · Negro

Length/Largo customizable

CANOPY
FLORÓN

Steel painted in black matt
Acero pintado en negro mate
230V: Ø12cm | 4,7"
120V: Ø12cm | 4,7"

4 x REF. PIEZA002
Finish black matt

AGO4-4-P



LIGHT SOURCE
FUENTE DE LUZ

Recommended bulbs
Bombillas recomendadas

230 V | 50 Hz  E27 LED Vintage-
Max. 4x12 W

120 V | 60 Hz  E26 LED - Max. 4x12 W

NET WEIGHT
PESO NETO

4,5 kg | 9,9 lb

PACKAGING
EMBALAJE

46x24x25 cm | 18,1x9,4x9,8"
44x44x40 cm | 17,3x17,3x15,7"
47x47x63 cm | 18,5x18,5x24,8"
51x51x53 cm | 20x20x20,9"
10,6 kg | 23,4 lb

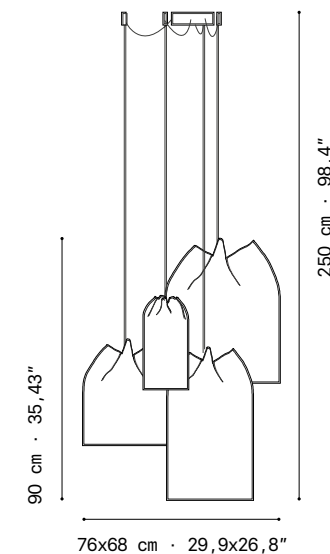

Ballet

Héctor Serrano, 2016

p. 40

MATERIALS Painted stainless steel
MATERIALES Acero inoxidable pintado

Stainless steel
Acero inoxidable

FINISHES White · Blanco (BL)
ACABADOS Beige · Beige (BE)

Grey · Gris (G)

Taupe · Topo (T)

Custom · Personalizado (CC)

LAMPSHADE ref. 1xBAPI04, 1xBARE04,
TULIPA 1xBALAO4

CABLE Transparent or black
Transparente o negro

Lenght/Largo customizable

CANOPY DIBOND®
FLORÓN 230V: Ø60cm | 23,6"
120V: Ø60cm | 23,6"

BA04-3

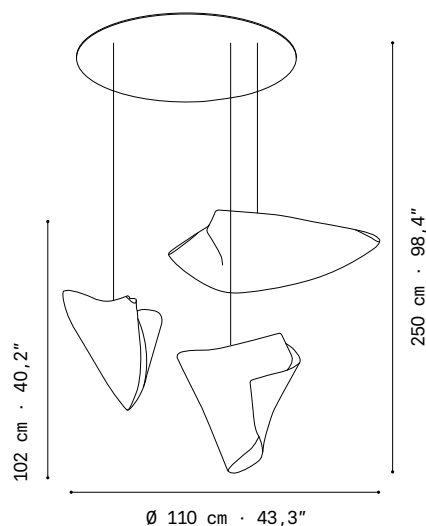

LIGHT SOURCE Recommended bulbs
FUENTE DE LUZ Bombillas recomendadas

230 V | 50 Hz E27 LED Vintage-
Max. 3x12 W

120 V | 60 Hz E26 LED - Max. 3x12 W

NET WEIGHT 5,7 kg | 12,6 lb
PESO NETO

PACKAGING 60x80x118 cm | 23,6x31,5x46,5"
EMBALAJE 14 kg | 30,2 lb

Ballet

Héctor Serrano, 2016

p. 40

MATERIALS Painted stainless steel
MATERIALES Acero inoxidable pintado

Stainless steel
Acero inoxidable

FINISHES White · Blanco (BL)
ACABADOS Beige · Beige (BE)

Grey · Gris (G)

Taupe · Topo (T)

Custom · Personalizado (CC)

LAMPSHADE ref. 1xBAPI04, 1xBARE04,
TULIPA 1xBALAO4

CABLE Transparent or black
Transparente o negro

Lenght/Largo customizable

CANOPY Steel gloss nickel- plated
FLORÓN Acero niquel-satinado
230V: Ø12cm | 4,7"
120V: Ø12cm | 4,7"

3 x REF. PIEZA002
Finish nickel-plated

BA04-3-P

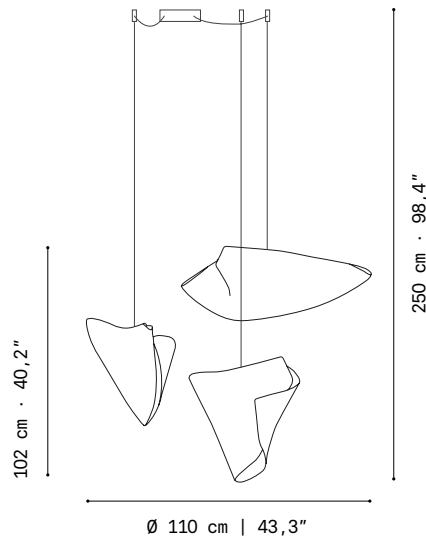

LIGHT SOURCE Recommended bulbs
FUENTE DE LUZ Bombillas recomendadas

230 V | 50 Hz E14 LED Vintage-
Max. 3x12 W

120 V | 60 Hz E12 LED - Max. 3x12 W

NET WEIGHT 3,5 kg | 7,7 lb
PESO NETO

PACKAGING 60x60x33 cm | 23,6x23,6x13"
EMBALAJE 44x44x40 cm | 17,3x17,3x15,7"
44x44x40 cm | 17,3x17,3x15,7"
7,8 kg | 17,2 lb

Coral

Arturo Álvarez, 2011

p. 40

MATERIALS Painted stainless steel
MATERIALES Acero inoxidable pintado

Stainless steel
Acero inoxidable

FINISHES White · Blanco (BL)
ACABADOS Beige · Beige (BE)

Grey · Gris (G)

Taupe · Topo (T)

Custom · Personalizado (CC)

LAMPSHADE ref. 1xCOAU04, 1xCOSE04,
TULIPA 1xCOGA04

CABLE Transparent or black
Transparente o negro

Lenght/Largo customizable

CANOPY DIBOND®
FLORÓN 230V: Ø60cm | 23,6"
120V: Ø60cm | 23,6"

C004-3

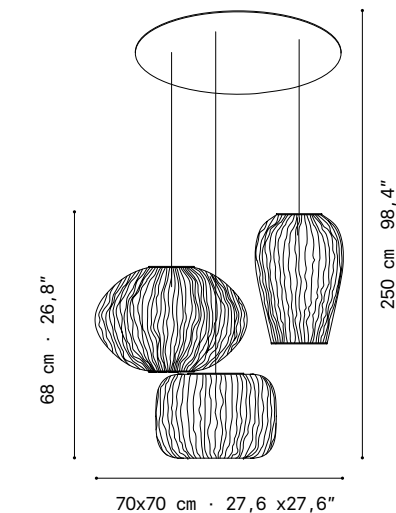

LIGHT SOURCE Recommended bulbs
FUENTE DE LUZ Bombillas recomendadas

230 V | 50 Hz E27 LED Vintage-
Max. 3x12 W

120 V | 60 Hz E26 LED - Max. 3x12 W

NET WEIGHT 6,9 kg | 15,2 lb
PESO NETO

PACKAGING 60x80x86 cm | 23,6x31,5x33,8"
EMBALAJE 12 kg | 26,5 lb

Coral

Arturo Álvarez, 2011

p. 40

MATERIALS Painted stainless steel
MATERIALES Acero inoxidable pintado

Stainless steel
Acero inoxidable

FINISHES White · Blanco (BL)
ACABADOS Beige · Beige (BE)

Grey · Gris (G)

Taupe · Topo (T)

Black · Negro (N)
Custom · Personalizado (CC)

LAMPSHADE ref. 1xCOAU04, 1xCOSE04,
TULIPA 1xCOGA04

CABLE Transparent or black
Transparente o negro

Lenght/Largo customizable

CANOPY Steel gloss nickel- plated
FLORÓN Acero niquel-satinado
230V: Ø12cm | 4,7"
120V: Ø12cm | 4,7"

3 x REF. PIEZA002
Finish nickel-plated

C004-3-P

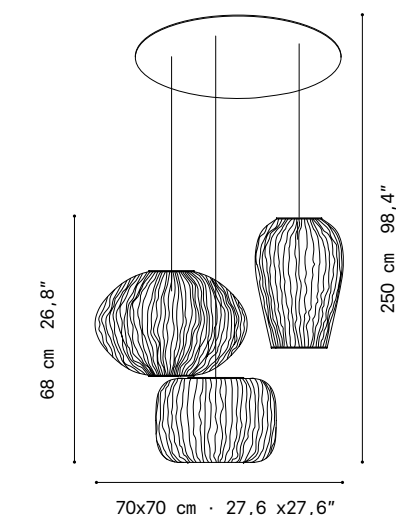

LIGHT SOURCE Recommended bulbs
FUENTE DE LUZ Bombillas recomendadas

230 V | 50 Hz E27 LED Vintage-
Max. 3x12 W

120 V | 60 Hz E26 LED - Max. 3x12 W

NET WEIGHT 4 kg | 8,9 lb
PESO NETO

PACKAGING 44x44x40 cm | 17,3x17,3x15,7"
EMBALAJE 44x44x40 cm | 17,3x17,3x15,7"
36x36x30 cm | 14,2x14,2x11,8"
6,2 kg | 13,6 lb

Coral

Arturo Álvarez, 2011

p. 40

MATERIALS Painted stainless steel
MATERIALES Acero inoxidable pintado

Stainless steel
Acero inoxidable

FINISHES White · Blanco (BL)
ACABADOS Beige · Beige (BE)

Grey · Gris (G)

Taupe · Topo (T)

Custom · Personalizado (CC)

LAMPSHADE ref. 1xCOAU04, 1xCOCY04,
TULIPA 1xCOSE04, 1xCOGA04, 1xCORE04

CABLE Transparent or black
Transparente o negro

Lenght/Largo customizable

CANOPY DIBOND®
FLORÓN 230V: Ø60cm | 23,6"
120V: Ø60cm | 23,6"

C004-5

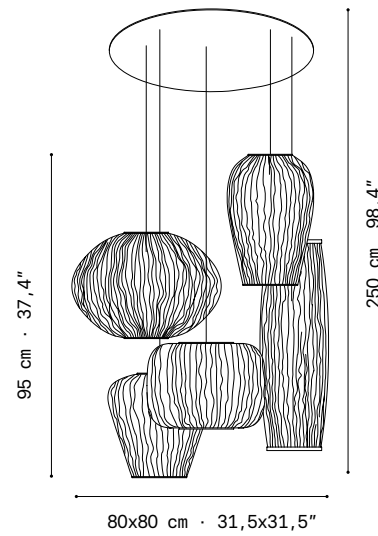

LIGHT SOURCE Recommended bulbs
FUENTE DE LUZ Bombillas recomendadas

230 V | 50 Hz (E27 LED Vintage- Max. 5x12 W)

120 V | 60 Hz (E26 LED - Max. 5x12 W)

NET WEIGHT 9,6 kg | 21,2 lb
PESO NETO

PACKAGING 60x80x118 cm | 23,6x31,5x46,5"
EMBALAJE 17,5 kg | 38,6 lb

Coral

Arturo Álvarez, 2011

p. 40

MATERIALS Painted stainless steel
MATERIALES Acero inoxidable pintado

Stainless steel
Acero inoxidable

FINISHES White · Blanco (BL)
ACABADOS Beige · Beige (BE)

Grey · Gris (G)

Taupe · Topo (T)

Custom · Personalizado (CC)

LAMPSHADE ref. 2xCOAU04, 1xCOCY04,
TULIPA 2xCOSE04, 2xCOGA04, 2xCORE04,
1xCOAU04G

CABLE Transparent or black
Transparente o negro

Lenght/Largo customizable

CANOPY DIBOND®
FLORÓN 230V: Ø120cm | 47,2"
120V: Ø120cm | 47,2"

C004-10

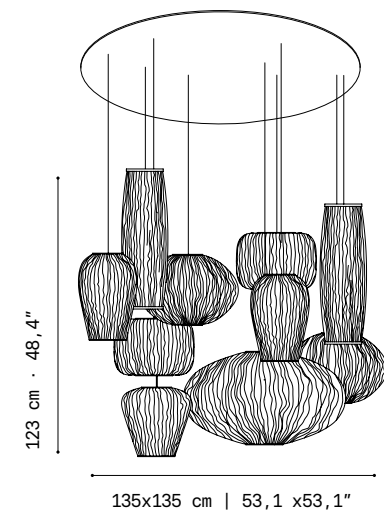

LIGHT SOURCE Recommended bulbs
FUENTE DE LUZ Bombillas recomendadas

230 V | 50 Hz (E27 LED Vintage- Max. 13x12 W)

120 V | 60 Hz (E26 LED - Max. 10x12 W)

NET WEIGHT 35,3 kg | 77,8 lb
PESO NETO

PACKAGING 80x125x138 cm | 31,5x49,2x54,3"
EMBALAJE 56 kg | 123,5 lb

Coral

Arturo Álvarez, 2011

p. 40

MATERIALS Painted stainless steel
MATERIALES Acero inoxidable pintado

Stainless steel
Acero inoxidable

FINISHES White · Blanco (BL)
ACABADOS Beige · Beige (BE)

Grey · Gris (G)

Taupe · Topo (T)

Black · Negro (N)

Custom · Personalizado (CC)

LAMPSHADE ref. 1xCOAU04, 1xCOCY04,
TULIPA 1xCOSE04, 1xCOGA04, 1xCORE04

CABLE Transparent or black
Transparente o negro

Lenght/Largo customizable

CANOPY Steel gloss nickel- plated
FLORÓN Acero niquel-satinado
230V: Ø12cm | 4,7"
120V: Ø12cm | 4,7"

3 x REF. PIEZA002
Finish nickel-plated

C004-5-P

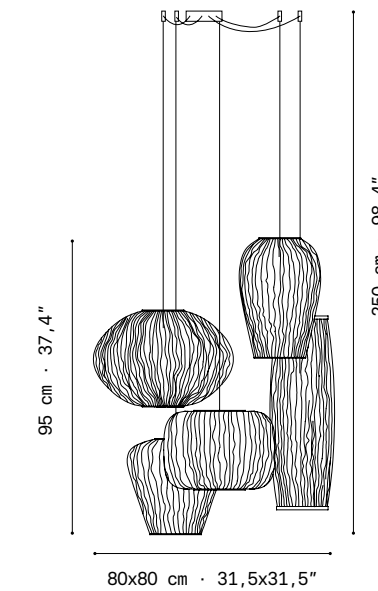

LIGHT SOURCE Recommended bulbs
FUENTE DE LUZ Bombillas recomendadas

230 V | 50 Hz (E27 LED Vintage- Max. 5x12 W)

120 V | 60 Hz (E26 LED - Max. 5x12 W)

NET WEIGHT 7,4kg | 16,3lb
PESO NETO

PACKAGING 44x44x40 cm | 17,3x17,3x15,7"
EMBALAJE 44x44x40 cm | 17,3x17,3x15,7"
36x36x30 cm | 14,2x14,2x11,8"
36x36x30 cm | 14,2x14,2x11,8"
66x32x23 cm | 26x12,6x9,1"
10 kg | 22 lb

Curvas

Arturo Álvarez, 2004

p. 40

MATERIALS Glass
MATERIALES Vidrio

FINISHES 02 (light grey)
ACABADOS 87 (orange), 89 (brown), 90 (dark brown)

LAMPSHADE ref. 3xCV04
TULIPA

CABLE Transparent or black
Transparente o negro

Lenght/Largo customizable

CANOPY DIBOND®
FLORÓN 230V: Ø60cm | 23,6"
120V: Ø60cm | 23,6"

DIFFUSER Bottom diffuser
DIFUSOR Difusor inferior

CV04C-3

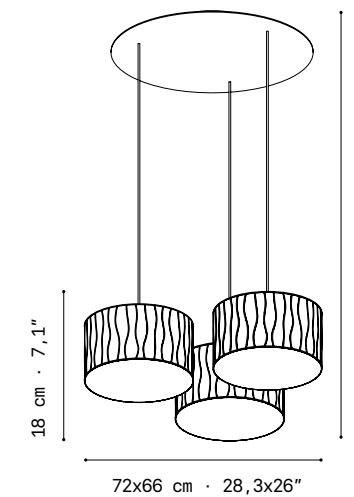

LIGHT SOURCE Recommended bulbs
FUENTE DE LUZ Bombillas recomendadas

230 V | 50 Hz (E27 LED Vintage- Max. 3x12 W)

120 V | 60 Hz (E26 LED - Max. 3x12 W)

NET WEIGHT 8 kg | 17,6 lb
PESO NETO

PACKAGING 60x80x95 cm | 23,6x31,5x37,4"
EMBALAJE 16 kg | 35 lb

Curvas

Arturo Álvarez, 2004

p. 40

MATERIALS
MATERIALES Glass
Vidrio

FINISHES
ACABADOS 02  87  89  90 

LAMPSHADE
TULIPA ref. 7xCV04

CABLE Transparent or black
Transparente o negro

Lenght/Largo customizable

CANOPY
FLORÓN DIBOND®
230V: Ø100cm | 39,4"
120V: Ø100cm | 39,4"

DIFFUSER
DIFUSOR Bottom diffuser
Difusor inferior

CV04-7

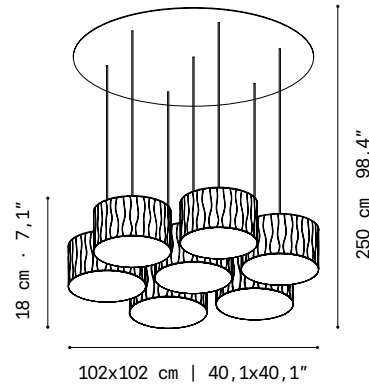

LIGHT SOURCE
FUENTE DE LUZ Recommended bulbs
Bombillas recomendadas

230 V | 50 Hz  E27 LED Vintage-
Max. 7x12 W

120 V | 60 Hz  E26 LED - Max. 7x12 W

NET WEIGHT
PESO NETO 18 kg | 39,7 lb

PACKAGING
EMBALAJE 80x120x125 cm | 31,5x47,2x49,2"
35 kg | 77 lb

Fluo

Arturo Álvarez, 2009

p. 40

MATERIALS
MATERIALES Galvanized painted steel
Acero galvanizado pintado

FINISHES
ACABADOS Stainless steel
Acero inoxidable

White · Blanco  B

Custom · Personalizado  CC

LAMPSHADE
TULIPA ref. 16xFL04

CABLE Transparent
Transparente

Lenght/Largo customizable

CANOPY
FLORÓN Stainless steel
Acero inoxidable
230V: Ø14cm | 5,51" h14cm | 5,5"
120V: Ø14cm | 5,51" h14cm | 5,5"
*Height is not adjustable on site
*Altura no ajustable in situ

FL04-16

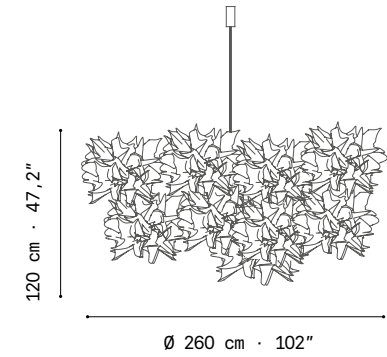

LIGHT SOURCE
FUENTE DE LUZ Recommended bulbs
Bombillas recomendadas

230 V | 50 Hz  E27 LED Vintage-
Max. 16x12 W

120 V | 60 Hz  E26 LED - Max. 16x12 W

NET WEIGHT
PESO NETO 57 kg | 125,6 lb

PACKAGING
EMBALAJE 77x82x200 cm | 30,3x32,3x78,7"
80x120x200 cm | 31,5x47,2x78,7"
77x82x77 cm | 30,3x32,3x30,3"
135 kg | 297 lb

Fluo

Arturo Álvarez, 2009

p. 40

MATERIALS
MATERIALES Galvanized painted steel
Acero galvanizado pintado

FINISHES
ACABADOS Stainless steel
Acero inoxidable

White · Blanco  B

Custom · Personalizado  CC

LAMPSHADE
TULIPA ref. 4xFL04

CABLE Transparent
Transparente

Lenght/Largo customizable

CANOPY
FLORÓN Stainless steel
Acero inoxidable
230V: Ø14cm | 5,51" h10cm | 3,9"
120V: Ø14cm | 5,51" h10cm | 3,9"

FL04-4

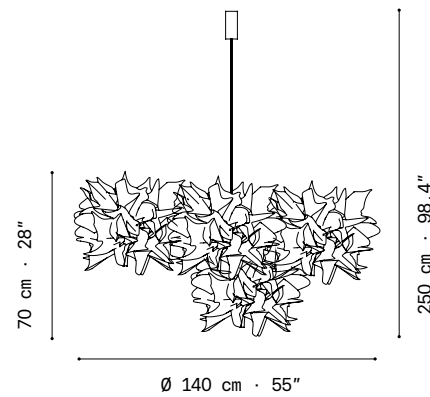

LIGHT SOURCE
FUENTE DE LUZ Recommended bulbs
Bombillas recomendadas

230 V | 50 Hz  E27 LED Vintage-
Max. 4x12 W

120 V | 60 Hz  E26 LED - Max. 4x12 W

NET WEIGHT
PESO NETO 11,3 kg | 25 lb

PACKAGING
EMBALAJE 77x82x139 cm | 30,3x32,3x54,7"
22 kg | 48,5 lb
77x82x139 cm | 30,3x32,3x54,7"
20 kg | 44,1 lb

Mytilus

Arturo Álvarez, 2019

p. 40

MATERIALS
MATERIALES Painted stainless steel
Acero inoxidable pintado

FINISHES
ACABADOS White · Blanco  BL

Black · Negro  N

LAMPSHADE
TULIPA ref. 3xMY04G

CABLE Transparent
Transparente

Lenght/Largo customizable

CANOPY
FLORÓN Steel painted in black
or white
Acero pintado en negro
o blanco
230V: Ø15(12)cm | 5,9(4,7)"
120V: Ø15(12)cm | 5,9(4,7)"

MY04-3

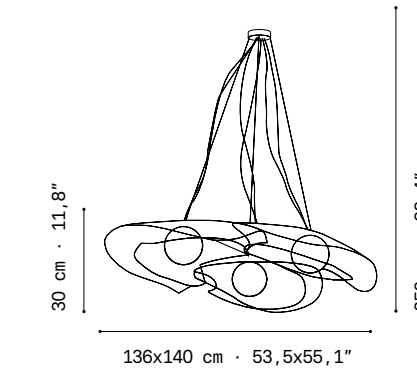

LIGHT SOURCE
FUENTE DE LUZ Light source built in
Fuente de luz incluida

230 V | 50 Hz  25W | 3000K | 2880lm built in
upon request 2700K 3201lm
Dimmer: PHASE CUT
upon request DALI/ Switch DIM 

100-277 V | 60 Hz  25W | 3000K | 3201lm built in
upon request 2700K 2880lm
Dimmer: PHASE CONTROL & 0-10V
(only 120Vac TRIAC Dimmers)

NET WEIGHT
PESO NETO 25,5 kg | 56,2 lb

PACKAGING
EMBALAJE 82x97x105 cm | 35,4x38,2x41,3"
28 kg | 61,7 lb

Nevo

Arturo Álvarez, 2007

p. 40

MATERIALS Painted stainless steel
MATERIALES Acero inoxidable pintado

Steel gloss nickel-plated and stainless steel
Acero níquel-satinado y acero inoxidable

FINISHES White · Blanco (BL)
ACABADOS Beige · Beige (BE)

Grey · Gris (G)

Taupe · Topo (T)

Custom · Personalizado (CC)

LAMPSHADE ref. 3xNE06P, 3xNE04-1
TULIPA

CABLE Transparent
Transparente

Lenght/Largo customizable

CANOPY DIBOND®
FLORÓN 230V: Ø60cm | 23,6"
120V: Ø60cm | 23,6"

NEO4-6

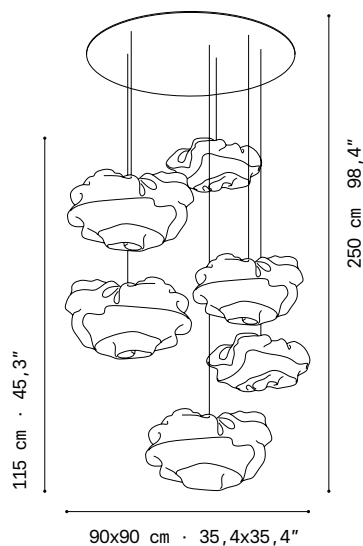

LIGHT SOURCE Recommended bulbs
FUENTE DE LUZ Bombillas recomendadas

230 V | 50 Hz E14 LED Vintage- Max. 9x7 W

120 V | 60 Hz E12 LED - Max. 9x7 W

NET WEIGHT 9,4 kg | 20,7 lb
PESO NETO

PACKAGING 60x80x106 cm | 23,6x31,5x41,2"
EMBALAJE 20 kg | 40 lb

Parga

Cenlitros, 2023

p. 40

MATERIALS Stone
MATERIALES Piedra

Painted stainless steel
Acero inoxidable pintado

FINISHES Natural color (●)
ACABADOS Color natural

Black · Negro (●)

LAMPSHADE ref. 1xPA104, 1xPA204,
TULIPA 1xPA304

CABLE Black · Negro

Lenght/Largo customizable

CANOPY Steel painted in matt black
FLORÓN Acero pintado en negro mate
230V: Ø14cm | 5,6"
120V: Ø14cm | 5,6"

2 x REF. PIEZA006



PA04-3-L

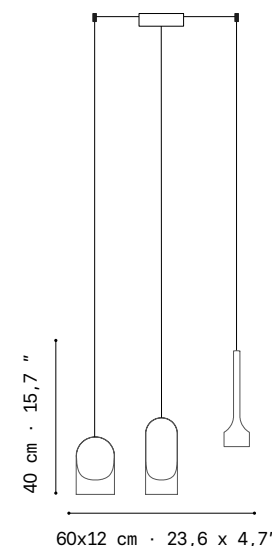

LIGHT SOURCE Light source built in
FUENTE DE LUZ Fuente de luz incluida

230 V | 50 Hz 18W | 2700K | 2520lm built in
upon request 3000K 2841lm
Dimmer: PHASE CUT
upon request DALI/ Switch DIM

100~277 V | 60 Hz 18W | 2700K | 2520lm built in
upon request 3000K 2841lm
Dimmer: PHASE CONTROL & 0-10V
(only 120Vac TRIAC Dimmers)

NET WEIGHT 6,5 kg | 14,9 lb
PESO NETO

PACKAGING 36x26x19 cm | 14,2x10,2x7,5"
EMBALAJE 36x26x19 cm | 14,2x10,2x7,5"
20x20x34 cm | 17,9x7,9x13,4"
7,2 kg | 15,9 lb

Nevo

Arturo Álvarez, 2007

p. 40

MATERIALS Painted stainless steel
MATERIALES Acero inoxidable pintado

Steel gloss nickel-plated and stainless steel
Acero níquel-satinado y acero inoxidable

FINISHES White · Blanco (BL)
ACABADOS Beige · Beige (BE)

Grey · Gris (G)

Taupe · Topo (T)

Custom · Personalizado (CC)

LAMPSHADE ref. 4xNE06P, 7xNE04-1
TULIPA

CABLE Transparent
Transparente

Lenght/Largo customizable

CANOPY DIBOND®
FLORÓN 230V: Ø120cm | 47,2"
120V: Ø120cm | 47,2"

NEO4-11

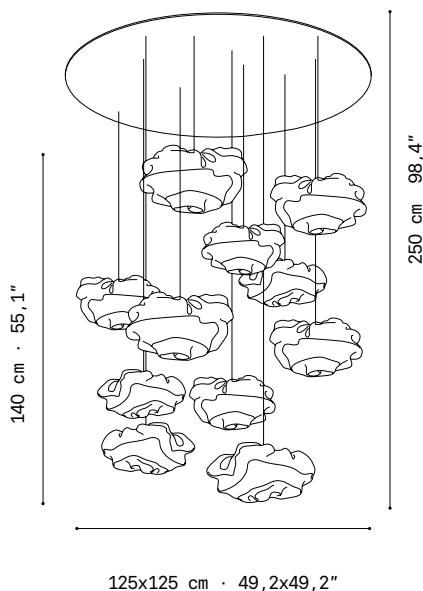

LIGHT SOURCE Recommended bulbs
FUENTE DE LUZ Bombillas recomendadas

230 V | 50 Hz E14 LED Vintage- Max. 18x7 W

120 V | 60 Hz E12 LED - Max. 18x7 W

NET WEIGHT 10 kg | 22 lb
PESO NETO

PACKAGING 80x125x135 cm | 31,5x49,2x53,1"
EMBALAJE 53 kg | 116,8 lb

Parga

Cenlitros, 2023

p. 40

MATERIALS Stone
MATERIALES Piedra

Painted stainless steel
Acero inoxidable pintado

FINISHES Natural color (●)
ACABADOS Color natural

Black · Negro (●)

LAMPSHADE ref. 1xPA104, 1xPA204,
TULIPA 1xPA304

CABLE Black · Negro

Lenght/Largo customizable

CANOPY Steel painted in matt black
FLORÓN Acero pintado en negro mate
230V: Ø14cm | 5,6"
120V: Ø14cm | 5,6"

3 x REF. PIEZA006

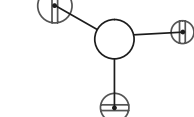

DIFFUSER Bottom diffuser
DIFUSOR Difusor inferior

PA04-3-R

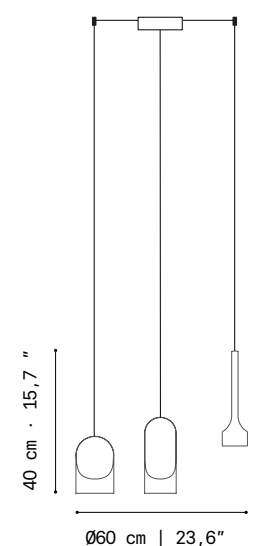

LIGHT SOURCE Light source built in
FUENTE DE LUZ Fuente de luz incluida

230 V | 50 Hz 24W | 2700K | 960lm built in
upon request 3000K 1067lm
Dimmer: PHASE CUT
upon request DALI/ Switch DIM

100~277 V | 60 Hz 24W | 2700K | 960lm built in
upon request 3000K 1067lm
Dimmer: PHASE CONTROL & 0-10V
(only 120Vac TRIAC Dimmers)

NET WEIGHT 2,2 kg | 4,8 lb
PESO NETO

PACKAGING 20x20x34 cm | 7,9x7,9x13,4"
EMBALAJE 20x20x34 cm | 7,9x7,9x13,4"
2,5 kg | 5,5 lb

Tati

Arturo Álvarez, 2011 p. 40

MATERIALS Painted stainless steel
MATERIALES Acero inoxidable pintado

Steel gloss nickel- plated and stainless steel
Acero níquel-satinado y acero inoxidable

- FINISHES ACABADOS
- White · Blanco BL
 - Beige · Beige BE
 - Grey · Gris G
 - Taupe · Topo T
 - Custom · Personalizado CC

LAMPSHADE TULIPA ref. 3xTA06G

CABLE Transparent
Transparente

Lenght/Largo customizable

CANOPY FLORÓN DIBOND®
230V: Ø60cm | 23,6"
120V: Ø60cm | 23,6"

TA04-3

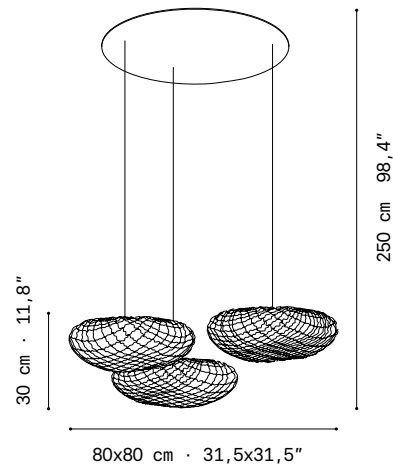

LIGHT SOURCE Recommended bulbs
FUENTE DE LUZ Bombillas recomendadas

230 V | 50 Hz E14 LED Vintage-
Max. 6x7 W

120 V | 60 Hz E12 LED - Max. 6x7 W

NET WEIGHT 6 kg | 13,2 lb
PESO NETO

PACKAGING 60x80x82 cm | 23,6x31,5x32,3"
EMBALAJE 19 kg | 41,9 lb

Tati

Arturo Álvarez, 2011

MATERIALS Painted stainless steel
MATERIALES Acero inoxidable pintado

Steel gloss nickel- plated and stainless steel
Acero níquel-satinado y acero inoxidable

- FINISHES ACABADOS
- White · Blanco BL
 - Beige · Beige BE
 - Grey · Gris G
 - Taupe · Topo T
 - Custom · Personalizado CC

LAMPSHADE TULIPA ref. 6xTA06G, 4xTA06P

CABLE Transparent
Transparente

Lenght/Largo customizable

CANOPY FLORÓN DIBOND®
230V: Ø120cm | 47,2"
120V: Ø120cm | 47,2"

TA04-10

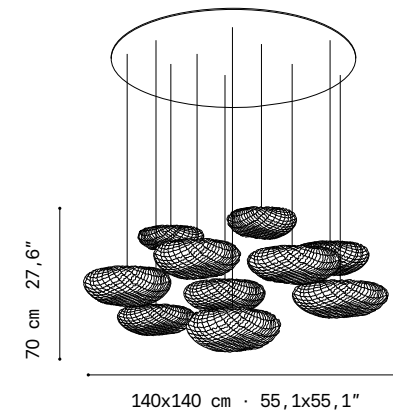

LIGHT SOURCE Recommended bulbs
FUENTE DE LUZ Bombillas recomendadas

230 V | 50 Hz E14 LED Vintage-
Max. 16x7 W

120 V | 60 Hz E12 LED - Max. 16x7 W

NET WEIGHT 19 kg | 41,9 lb
PESO NETO

PACKAGING 80x125x135 cm | 31,5x49,2x53,1"
EMBALAJE 55kg | 121,3 lb

Tati

Arturo Álvarez, 2011

MATERIALS Painted stainless steel
MATERIALES Acero inoxidable pintado

Steel gloss nickel- plated and stainless steel
Acero níquel-satinado y acero inoxidable

- FINISHES ACABADOS
- White · Blanco BL
 - Beige · Beige BE
 - Grey · Gris G
 - Taupe · Topo T
 - Custom · Personalizado CC

LAMPSHADE TULIPA ref. 3xTA06G, 2xTA06P

CABLE Transparent
Transparente

Lenght/Largo customizable

CANOPY FLORÓN DIBOND®
230V: Ø60cm | 23,6"
120V: Ø60cm | 23,6"

TA04-5

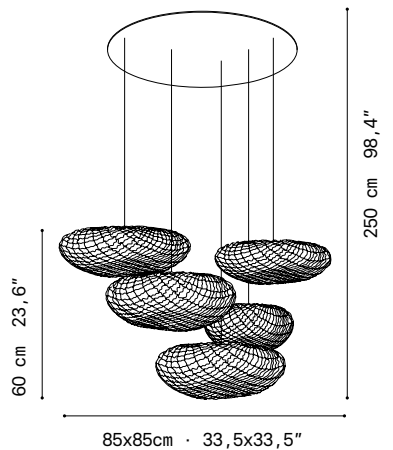

LIGHT SOURCE Recommended bulbs
FUENTE DE LUZ Bombillas recomendadas

230 V | 50 Hz E14 LED Vintage-
Max. 8x7 W

120 V | 60 Hz E12 LED - Max. 8x7 W

NET WEIGHT 8,9 kg | 19,6 lb
PESO NETO

PACKAGING 60x80x82 cm | 23,6x31,5x32,3"
EMBALAJE 25 kg | 55,1 lb

Ura

Arturo Álvarez, 2017 p. 40

MATERIALS Painted stainless steel
MATERIALES Acero inoxidable pintado

Stainless steel
Acero inoxidable

- FINISHES ACABADOS
- White · Blanco BL
 - Beige · Beige BE
 - Grey · Gris G
 - Taupe · Topo T
 - Black · Negro N
 - Custom · Personalizado CC

LAMPSHADE TULIPA ref. 1xUR104, 1xUR204,
1xUR304

CABLE Transparent or black
Transparente o negro

Lenght/Largo customizable

CANOPY FLORÓN DIBOND®
230V: Ø60cm | 23,6"
120V: Ø60cm | 23,6"

UR04-3

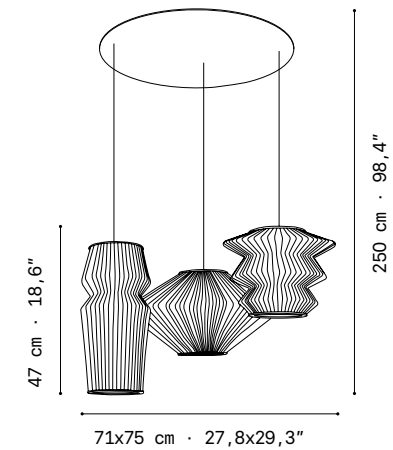

LIGHT SOURCE Recommended bulbs
FUENTE DE LUZ Bombillas recomendadas

230 V | 50 Hz E27 LED Vintage-
Max. 3x12 W

120 V | 60 Hz E26 LED - Max. 3x12 W

NET WEIGHT 10,2 kg | 22,5 lb
PESO NETO

PACKAGING 60x80x95 cm | 23,6x31,5x37,4"
EMBALAJE 10,2 kg | 22,5 lb

Brétema

Brétema

a-emotional light design team, p. 40
2025

MATERIALS Painted stainless steel
MATERIALES Acero inoxidable pintado

FINISHES White · Blanco (BL)
ACABADOS

CABLE Black · Negro

Lenght/Largo customizable

BR04S

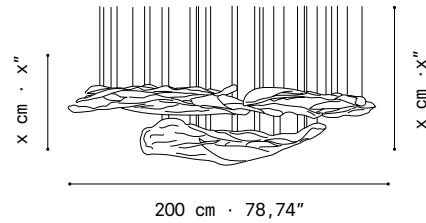

Depth · Profundidad
150 cm | 59,1\"/>

LIGHT SOURCE Recommended bulbs
FUENTE DE LUZ Bombillas recomendadas
230 V | 50 Hz 3x4W 2700K 600lm built in

BR04M

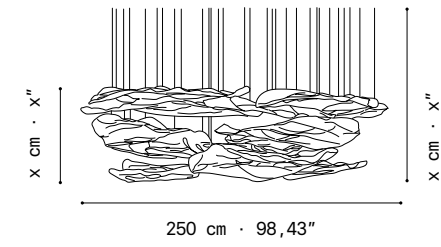

Depth · Profundidad
200 cm | 78,7\"/>

LIGHT SOURCE Recommended bulbs
FUENTE DE LUZ Bombillas recomendadas
230 V | 50 Hz 2x4W 2700K 600lm built in

BR04L

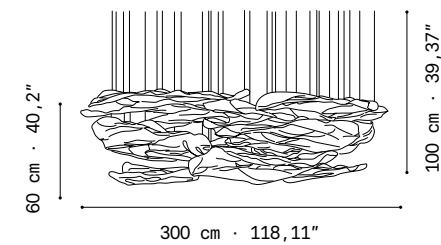

Depth · Profundidad
230 cm | 90,6\"/>

LIGHT SOURCE Recommended bulbs
FUENTE DE LUZ Bombillas recomendadas
230 V | 50 Hz 2x4W 2700K 600lm built in

Wall & ceiling lamps

Apliques y plafones

Ballet

Héctor Serrano, 2016 p. 40

MATERIALS
MATERIALES Painted stainless steel
Acero inoxidable pintado

FINISHES
ACABADOS
White · Blanco (BL)
Beige · Beige (BE)
Grey · Gris (G)
Taupe · Topo (T)
Custom · Personalizado (CC)

SUPPORT
SOPORTE Painted steel
Acero pintado

MOUNTING OPTIONS
OPCIONES DE INSTALACIÓN
Wall lamp
Aplicue

DIFFUSER
DIFUSOR Inside diffuser
Difusor interno

BA06

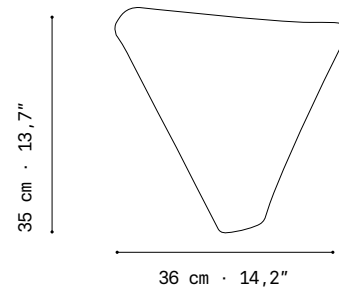

Depth · Profundidad
15 cm | 5,9"

LIGHT SOURCE
FUENTE DE LUZ Recommended bulbs
Bombillas recomendadas

230 V | 50 Hz E14 LED Vintage-
Max. 1x8 W

120 V | 60 Hz E12 LED - Max. 1x8 W

NET WEIGHT
PESO NETO 0,6 kg | 1,3 lb

PACKAGING
EMBALAJE 44x44x20 cm | 17,3x17,3x7,9"
1,9 kg | 4,2 lb

BA06-LD

LED

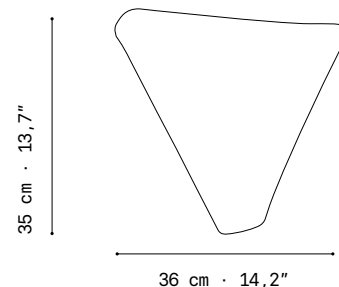

Depth · Profundidad
15 cm | 5,9"

LIGHT SOURCE
FUENTE DE LUZ Light source built in
Fuente de luz incluida

230 V | 50 Hz 8W | 2700K | 960lm built in
upon request 3000K 1067lm
Dimmer: PHASE CUT

100-277 V | 60 Hz 8W | 2700K | 960lm built in
upon request 3000K 1067lm
Dimmer: PHASE CONTROL & 0-10V
(only 120Vac TRIAC Dimmers)

NET WEIGHT
PESO NETO 1 kg | 2,3 lb

PACKAGING
EMBALAJE 44x44x20 cm | 17,3x17,3x7,9"
2,3 kg | 5,1 lb

Blum

Arturo Álvarez, 2015 p. 40

MATERIALS
MATERIALES Painted stainless thread
Hilo de acero
inoxidable pintado

FINISHES
ACABADOS White · Blanco (BL)

SUPPORT
SOPORTE Painted steel
Acero pintado

MOUNTING OPTIONS
OPCIONES DE INSTALACIÓN
Wall lamp
Aplicue

BL06

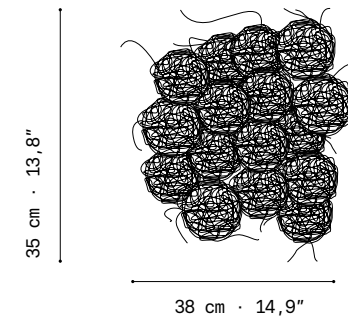

Depth · Profundidad
21 cm | 8,2"

LIGHT SOURCE
FUENTE DE LUZ Recommended bulbs
Bombillas recomendadas

230 V | 50 Hz E14 LED Vintage-
Max. 1x12 W

120 V | 60 Hz E12 LED - Max. 1x12 W

NET WEIGHT
PESO NETO 1,1 kg | 2,4 lb

PACKAGING
EMBALAJE 44x44x40 cm | 17,3x17,3x15,7"
1,5 kg | 3,3 lb

Cors

Arturo Álvarez, 2011 p. 40

MATERIALS
MATERIALES Painted stainless thread
Hilo de acero
inoxidable pintado

FINISHES
ACABADOS
White · Blanco (BL)
Beige · Beige (BE)
Grey · Gris (G)
Taupe · Topo (T)
Custom · Personalizado (CC)

SUPPORT
SOPORTE Stainless steel
Acero pintado

MOUNTING OPTIONS
OPCIONES DE INSTALACIÓN
Wall lamp
Aplicue

SUPPORT
SOPORTE Steel gloss nickel- plated
and stainless steel
Acero niquel-satinado y acero
inoxidable

MOUNTING OPTIONS
OPCIONES DE INSTALACIÓN
Wall lamp
Aplicue

DIFFUSER
DIFUSOR Inside diffuser
Difusor interno

CRO6

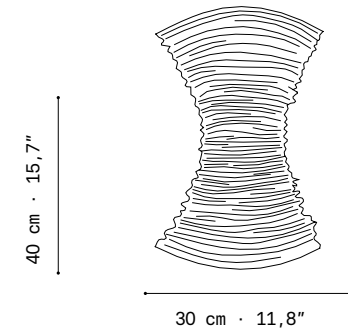

Depth · Profundidad
15 cm | 5,9"

LIGHT SOURCE
FUENTE DE LUZ Recommended bulbs
Bombillas recomendadas

230 V | 50 Hz G9 LED - Max. 2x4 W

120 V | 60 Hz G9 LED - Max. 2x4 W

NET WEIGHT
PESO NETO 0,6 kg | 1,3 lb

PACKAGING
EMBALAJE 51x19x27 cm | 20,1x7,5x10,6"
1 kg | 2,2 lb

CRO6-LD

LED

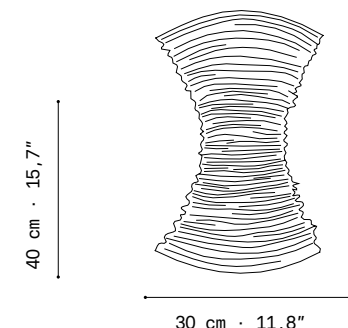

Depth · Profundidad
15 cm | 5,9"

LIGHT SOURCE
FUENTE DE LUZ Light source built in
Fuente de luz incluida

230 V | 50 Hz 17W | 2700K | 1645lm built in
upon request 3000K 1776lm
Dimmer: PHASE CUT

100-277 V | 60 Hz 17W | 2700K | 1645lm built in
upon request 3000K 1776lm
Dimmer: PHASE CONTROL & 0-10V
(only 120Vac TRIAC Dimmers)

NET WEIGHT
PESO NETO 1,1 kg | 2,4 lb

PACKAGING
EMBALAJE 51x19x27 cm | 20,1x7,5x10,6"
1,5 kg | 3,3 lb

Curvas

2004

p. 40

MATERIALS
MATERIALES Glass
Vidrio

FINISHES
ACABADOS 02  87  89  90 

SUPPORT
SOPORTE Stainless steel
Acero inoxidable

MOUNTING OPTIONS
OPCIONES DE INSTALACIÓN

Wall lamp
Aplicue

CV06



LIGHT SOURCE
FUENTE DE LUZ Recommended bulbs
Bombillas recomendadas

230 V | 50 Hz  E14 LED Vintage-
Max. 2x7 W

120 V | 60 Hz  E12 LED - Max. 2x7 W

NET WEIGHT
PESO NETO 1,7 kg | 3,7 lb

PACKAGING
EMBALAJE 65x32x23 cm | 25,6x12,6x9,1"
3 kg | 6,5 lb

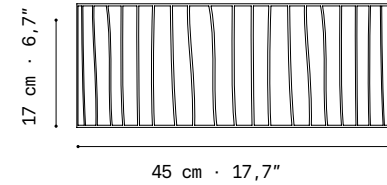





Depth · Profundidad
12 cm | 4,7"

Gea

Arturo Álvarez, 2009

p. 40

MATERIALS
MATERIALES Painted stainless steel
Acero inoxidable pintado

FINISHES
ACABADOS White · Blanco  Beige · Beige  Grey · Gris  Taupe · Topo 

Custom · Personalizado 

SUPPORT
SOPORTE Stainless steel
Acero inoxidable

MOUNTING OPTIONS
OPCIONES DE INSTALACIÓN

Wall lamp
Aplicue

SUPPORT 
SOPORTE Steel gloss nickel- plated
and stainless steel
Acero niquel-satinado y acero
inoxidable

MOUNTING OPTIONS
OPCIONES DE INSTALACIÓN

Wall lamp
Aplicue

DIFFUSER 
DIFUSOR Inside diffuser
Difusor interno

GE06



LIGHT SOURCE
FUENTE DE LUZ Recommended bulbs
Bombillas recomendadas

230 V | 50 Hz  G9 LED - Max. 2x4 W

120 V | 60 Hz  G9 LED - Max. 2x4 W

NET WEIGHT
PESO NETO 0,6 kg | 1,3 lb

PACKAGING
EMBALAJE 36x26x19 cm | 14,2x10,2x7,5"
1 kg | 2,2 lb

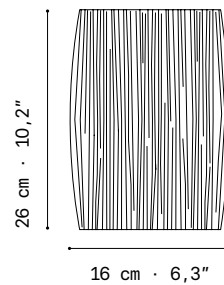

Depth · Profundidad
13 cm | 5,1"

GE06-LD



LIGHT SOURCE
FUENTE DE LUZ Light source built in
Fuente de luz incluida

230 V | 50 Hz  8W | 2700K | 960lm built in
upon request 3000K 10671m
Dimmer: PHASE CUT 

100-277 V |
60 Hz  8W | 2700K | 960lm built in
upon request 3000K 10671m
Dimmer: PHASE CONTROL & 0-10V
(only 120Vac TRIAC Dimmers)

NET WEIGHT
PESO NETO 1,1 kg | 2,4 lb

PACKAGING
EMBALAJE 36x26x19 cm | 14,2x10,2x7,5"
1,5 kg | 3,3 lb

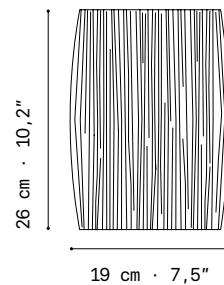





Depth · Profundidad
13 cm | 5,1"

Kala

Arturo Álvarez, 2011

p. 40

MATERIALS
MATERIALES Painted stainless steel
Acero inoxidable pintado

FINISHES
ACABADOS White · Blanco  Beige · Beige  Grey · Gris  Taupe · Topo 

Custom · Personalizado 

SUPPORT
SOPORTE Painted steel
Acero pintado

MOUNTING OPTIONS
OPCIONES DE INSTALACIÓN

Wall lamp
Aplicue

SUPPORT 
SOPORTE Steel gloss nickel- plated
and stainless steel
Acero niquel-satinado y acero
inoxidable

MOUNTING OPTIONS
OPCIONES DE INSTALACIÓN

Wall lamp
Aplicue

DIFFUSER 
DIFUSOR Inside diffuser
Difusor interno

KL06



LIGHT SOURCE
FUENTE DE LUZ Recommended bulbs
Bombillas recomendadas

230 V | 50 Hz  G9 LED - Max. 2x4 W

120 V | 60 Hz  G9 LED - Max. 2x4 W

NET WEIGHT
PESO NETO 0,6 kg | 1,3 lb

PACKAGING
EMBALAJE 36x26x19 cm | 14,2x10,2x7,5"
1 kg | 2,2 lb

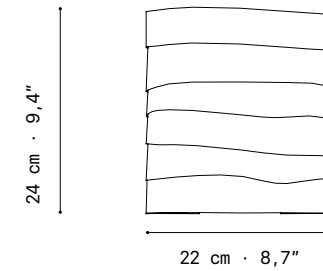

Depth · Profundidad
14 cm | 5,5"

KL06-LD



LIGHT SOURCE
FUENTE DE LUZ Light source built in
Fuente de luz incluida

230 V | 50 Hz  8W | 2700K | 960lm built in
upon request 3000K 10671m
Dimmer: PHASE CUT 

100-277 V |
60 Hz  8W | 2700K | 960lm built in
upon request 3000K 10671m
Dimmer: PHASE CONTROL & 0-10V
(only 120Vac TRIAC Dimmers)

NET WEIGHT
PESO NETO 1,1 kg | 2,4 lb

PACKAGING
EMBALAJE 36x26x19 cm | 14,2x10,2x7,5"
1,5 kg | 3,3 lb

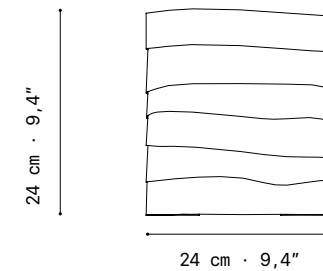



Depth · Profundidad
14 cm | 5,5"

Kite

Arturo Álvarez, 2011

p. 40

MATERIALS
MATERIALES Painted stainless steel
Acero inoxidable pintado

FINISHES
ACABADOS White · Blanco  Grey · Gris 

Custom · Personalizado 

SUPPORT
SOPORTE Painted steel
Acero pintado



MOUNTING OPTIONS
OPCIONES DE INSTALACIÓN

Wall & ceiling lamp
Aplicue & plafón

KT06-LD



LIGHT SOURCE
FUENTE DE LUZ Light source built in
Fuente de luz incluida

230 V | 50 Hz  17W | 2700K | 3636lm built in
upon request 3000K 37801m
Dimmer: PHASE CUT 

100-277 V |
60 Hz  17W | 2700K | 3636lm built in
upon request 3000K 37801m
Dimmer: PHASE CONTROL & 0-10V
(only 120Vac TRIAC Dimmers)

NET WEIGHT
PESO NETO 8,5 kg | 18,7 lb

PACKAGING
EMBALAJE 71x71x15 cm | 28x28x5,9"
9,2 kg | 20,3 lb

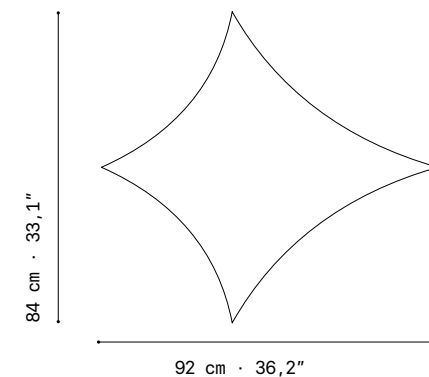

Depth · Profundidad
9 cm | 3,5"

KT06G-LD

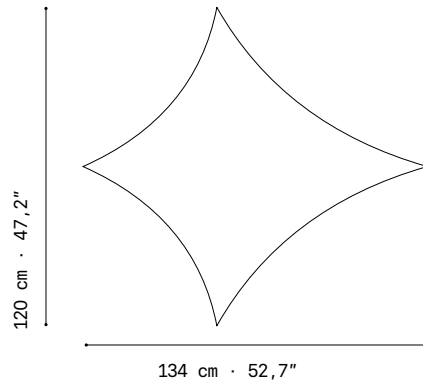

Depth · Profundidad
9 cm | 3,5"

LIGHT SOURCE Fuente de LUZ Light source built in Fuente de luz incluida

230 V | 50 Hz 34W | 2700K | 7272lm built in upon request 3000K 75601m Dimmer: PHASE CUT



100-277 V | 60 Hz 34W | 2700K | 7272lm built in upon request 3000K 75601m Dimmer: PHASE CONTROL & 0-10V (only 120Vac TRIAC Dimmers)

NET WEIGHT PESO NETO 7,5 kg | 16,5 lb

PACKAGING EMBALAJE 102x102x13 cm | 40,1x40,1x5,1" 11 kg | 24,2 lb

Li

Arturo Álvarez, 2013

p. 40

MATERIAL MATERIAL Pressed cellulose Celulosa prensada

- FINISHES ACABADOS
- | | |
|----|----|
| 42 | 49 |
| 43 | 50 |
| 46 | 51 |
| 47 | 52 |

SUPPORT SOPORTE Stainless steel Acero inoxidable

MOUNTING OPTIONS OPCIONES DE INSTALACIÓN Wall lamp Aplique

LI06

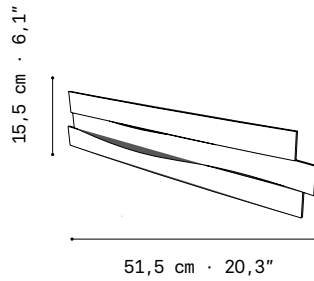

Depth · Profundidad
6,5 cm | 2,6"

LIGHT SOURCE Fuente de LUZ Light source built in Fuente de luz incluida

230 V | 50 Hz 11,8W | 2700K | 1604lm built in upon request 3000K 16541m Dimmer: PHASE CUT



100-277 V | 60 Hz 11,8W | 2700K | 1546lm built in upon request 3000K 18051m Dimmer: PHASE CONTROL & 0-10V (only 120Vac TRIAC Dimmers)

NET WEIGHT PESO NETO 1,2 kg | 2,6 lb

PACKAGING EMBALAJE 32x65x23 cm | 12,6x25,6x9" 2 kg | 4,4 lb

LI06G

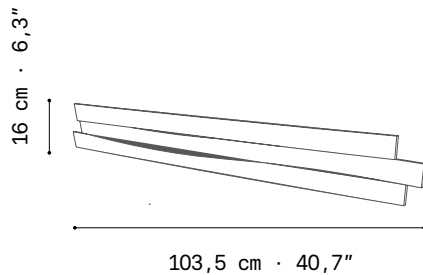

Depth · Profundidad
6,5 cm | 2,6"

LIGHT SOURCE Fuente de LUZ Light source built in Fuente de luz incluida

230 V | 50 Hz 17W | 2700K | 2558lm built in upon request 3000K 26321m Dimmer: PHASE CUT



NET WEIGHT PESO NETO 2,9 kg | 6,4 lb

PACKAGING EMBALAJE 110x31x25 cm | 43,3x12,2x9,8" 4,7 kg | 10,4 lb

LI06G-D

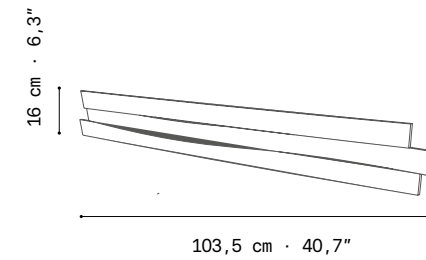

Depth · Profundidad
6,5 cm | 2,6"

LIGHT SOURCE Fuente de LUZ Light source built in Fuente de luz incluida

230 V | 50 Hz 23,6W | 2700K | 3020lm built in upon request 3000K 31151m Dimmer: PHASE CUT

100-277 V | 60 Hz 17W | 2700K | 2558lm built in upon request 3000K 26321m Dimmer: PHASE CONTROL & 0-10V (only 120Vac TRIAC Dimmers)

NET WEIGHT PESO NETO 2,9 kg | 6,4 lb

PACKAGING EMBALAJE 110x31x25 cm | 43,3x12,2x9,8" 4,7 kg | 10,4 lb

Lisa

a-emotional light team, 2025

p. 40

MATERIALS MATERIALES Painted stainless steel Acero inoxidable pintado

- FINISHES ACABADOS
- White · Blanco
 - Beige · Beige
 - Grey · Gris
 - Taupe · Topo
 - Black · Negro
 - Custom · Personalizado

SUPPORT SOPORTE Painted steel Acero pintado

MOUNTING OPTIONS OPCIONES DE INSTALACIÓN Wall lamp Aplique

LLO6

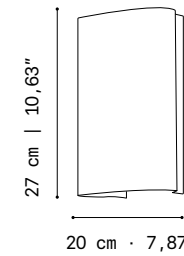

Depth · Profundidad
9,5 cm | 3,7"

LIGHT SOURCE Fuente de LUZ Recommended bulbs Bombillas recomendadas

230 V | 50 Hz G9 LED - Max. 2x4 W

120 V | 60 Hz G9 LED - Max. 2x4 W

NET WEIGHT PESO NETO 0,7 kg | 1,5 lb

PACKAGING EMBALAJE 36x26x19 cm | 14,2x10,2x7,5" 1 kg | 2,2 lb

LLO6G

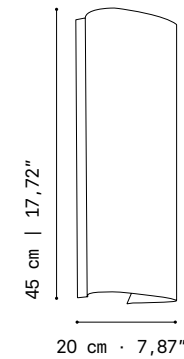

Depth · Profundidad
9 cm | 3,5"

LIGHT SOURCE Fuente de LUZ Recommended bulbs Bombillas recomendadas

230 V | 50 Hz G9 LED - Max. 2x4 W

120 V | 60 Hz G9 LED - Max. 2x4 W

NET WEIGHT PESO NETO 0,9 kg | 2 lb

PACKAGING EMBALAJE 56x26x19 cm | 22x10,2x7,5 kg

Mytilus

Arturo Álvarez, 2019

p. 40

MATERIALS Painted stainless steel
MATERIALES Acero inoxidable pintado

FINISHES White · Blanco (BL)
ACABADOS

SUPPORT Painted steel in white
SOPORTE Acero pintado en blanco

MOUNTING OPTIONS
OPCIONES DE INSTALACIÓN
Wall lamp
Aplicque

DIFFUSER Glass diffuser
DIFUSOR Difusor de vidrio

MY06

LED

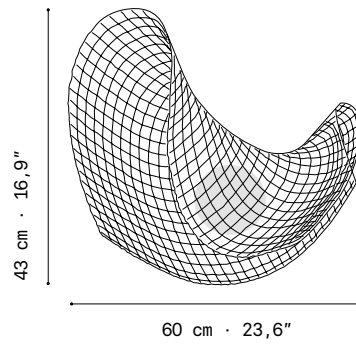

Depth · Profundidad
16 cm | 6,3"

LIGHT SOURCE Light source built in
FUENTE DE LUZ Fuente de luz incluida

230 V | 50 Hz 8W | 2700K | 960lm built in
upon request 3000K 10671m
Dimmer: PHASE CUT

100~277 V | 60 Hz 8W | 2700K | 960lm built in
upon request 3000K 10671m
Dimmer: PHASE CONTROL & 0-10V
(only 120Vac TRIAC Dimmers)

NET WEIGHT 3 kg | 6,6 lb
PESO NETO

PACKAGING 60x60x22 cm | 23,6x23,6x8,7"
EMBALAJE 4,5 kg | 9,9 lb

Nevo

Arturo Álvarez, 2007

p. 40

MATERIALS Painted stainless steel
MATERIALES Acero inoxidable pintado

Steel gloss nickel- plated
and stainless steel
Acero niquel-satinado y acero
inoxidable

FINISHES White · Blanco (BL)
ACABADOS

Beige · Beige (BE)

Grey · Gris (G)

Taupe · Topo (T)

Custom · Personalizado (CC)

SUPPORT Stainless steel
SOPORTE Acero inoxidable

MOUNTING OPTIONS
OPCIONES DE INSTALACIÓN
Wall lamp
Aplicque

SUPPORT Steel gloss nickel- plated
and stainless steel
SOPORTE Acero niquel-satinado y acero
inoxidable

MOUNTING OPTIONS
OPCIONES DE INSTALACIÓN
Wall lamp
Aplicque

DIFFUSER Inside diffuser
DIFUSOR Difusor interno

NE06P

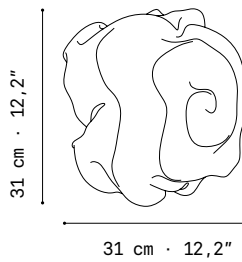

Depth · Profundidad
17 cm | 6,7"

LIGHT SOURCE Recommended bulbs
FUENTE DE LUZ Bombillas recomendadas

230 V | 50 Hz G9 LED - Max. 1x4 W

120 V | 60 Hz G9 LED - Max. 1x4 W

NET WEIGHT 0,8 kg | 1,8 lb
PESO NETO

PACKAGING 36x36x31 cm | 14,2x14,2x12,2"
EMBALAJE 1,8 kg | 4 lb

NE06P-LD

LED

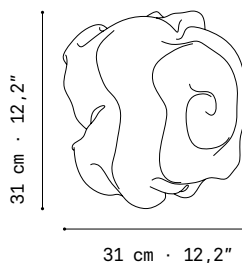

Depth · Profundidad
20 cm | 7,9"

LIGHT SOURCE Light source built in
FUENTE DE LUZ Fuente de luz incluida

230 V | 50 Hz 8W | 2700K | 960lm built in
upon request 3000K 10671m
Dimmer: PHASE CUT

100~277 V | 60 Hz 8W | 2700K | 960lm built in
upon request 3000K 10671m
Dimmer: PHASE CONTROL & 0-10V
(only 120Vac TRIAC Dimmers)

NET WEIGHT 1,2 kg | 2,6 lb
PESO NETO

PACKAGING 36x36x31 cm | 14,2x14,2x12,2"
EMBALAJE 1,8 kg | 4 lb

NE06

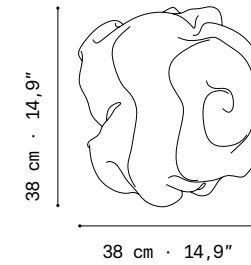

Depth · Profundidad
23 cm | 9"

LIGHT SOURCE Recommended bulbs
FUENTE DE LUZ Bombillas recomendadas

230 V | 50 Hz E14 LED Vintage-
Max. 2x7 W

120 V | 60 Hz E12 LED - Max. 2x7 W

NET WEIGHT 1,1 kg | 2,4 lb
PESO NETO

PACKAGING 36x36x31 cm | 14,2x14,2x12,2"
EMBALAJE 2,2 kg | 4,8 lb

NE06-LD

LED

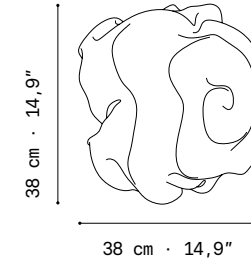

Depth · Profundidad
25 cm | 9,8"

LIGHT SOURCE Light source built in
FUENTE DE LUZ Fuente de luz incluida

230 V | 50 Hz 8W | 2700K | 960lm built in
upon request 3000K 10671m
Dimmer: PHASE CUT

100~277 V | 60 Hz 8W | 2700K | 960lm built in
upon request 3000K 10671m
Dimmer: PHASE CONTROL & 0-10V
(only 120Vac TRIAC Dimmers)

NET WEIGHT 1,4 kg | 3,1 lb
PESO NETO

PACKAGING 36x36x31 cm | 14,2x14,2x12,2"
EMBALAJE 2,2 kg | 4,8 lb

Onn

Arturo Álvarez, 2017

p. 40

MATERIALS Painted stainless steel
MATERIALES Acero inoxidable pintado

FINISHES White · Blanco (BL)
ACABADOS

Custom · Personalizado (CC)

SUPPORT Painted steel
SOPORTE Acero pintado

MOUNTING OPTIONS
OPCIONES DE INSTALACIÓN
Wall & ceiling lamp
Aplicque & plafón

ON06

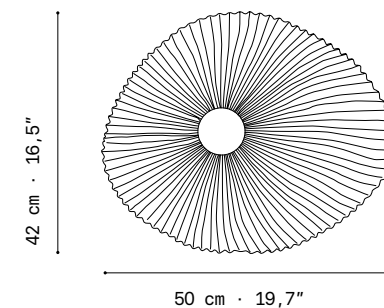

Depth · Profundidad
18 cm | 7,1"

LIGHT SOURCE Recommended bulbs
FUENTE DE LUZ Bombillas recomendadas

230 V | 50 Hz E27 LED Vintage-
Max. 1x8 W

120 V | 60 Hz E26 LED - Max. 1x8 W

NET WEIGHT 3 kg | 6,6 lb
PESO NETO

PACKAGING 46x52x30 cm | 18,1x20,5x11,8"
EMBALAJE 4,4 kg | 9,7 lb

ON06-LD

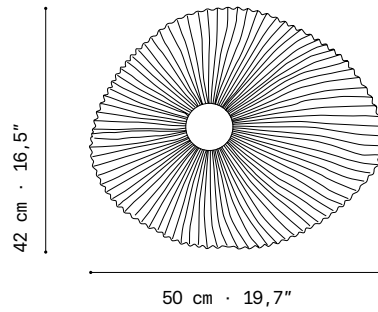

Depth · Profundidad
18 cm | 7,1"

LIGHT SOURCE Light source built in
FUENTE DE LUZ Fuente de luz incluida

230 V | 50 Hz 15W | 2700K | 2860lm built in
upon request 3000K 2945lm
Dimmer: PHASE CUT
upon request DALI/ Switch DIM

100~277 V | 60 Hz 15W | 2700K | 2860lm built in
upon request 3000K 2945lm
Dimmer: PHASE CONTROL & 0-10V
(only 120Vac TRIAC Dimmers)

NET WEIGHT 3,5 kg | 7,7 lb
PESO NETO

PACKAGING 46x52x30 cm | 18,1x20,5x11,8"
EMBALAJE 4,4 kg | 9,7 lb

ON06G

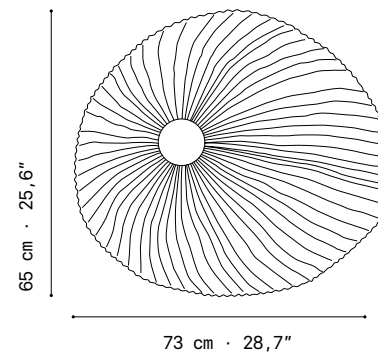

Depth · Profundidad
22 cm | 8,7"

LIGHT SOURCE Recommended bulbs
FUENTE DE LUZ Bombillas recomendadas

230 V | 50 Hz E27 LED Vintage-
Max. 3x8 W

120 V | 60 Hz E26 LED - Max. 3x8 W

NET WEIGHT 7 kg | 15,4 lb
PESO NETO

PACKAGING 71x71x32 cm | 28x28x12,6"
EMBALAJE 8 kg | 17,6 lb

Planum

Arturo Álvarez, 2008

p. 40

MATERIALS Painted stainless steel
MATERIALES Acero inoxidable pintado

FINISHES White · Blanco
ACABADOS

Grey · Gris

Custom · Personalizado

SUPPORT Steel painted in white
SOPORTE Acero pintado

MOUNTING OPTIONS
OPCIONES DE INSTALACIÓN

Wall & ceiling lamp
Aplique & plafón

PM06R-LD

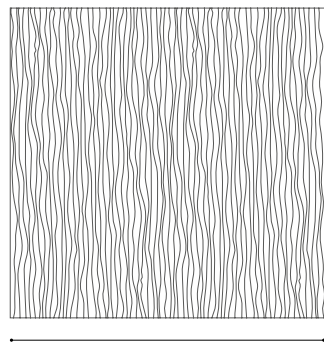

Depth · Profundidad
8 cm | 3,1"

LIGHT SOURCE Light source built in
FUENTE DE LUZ Fuente de luz incluida

230 V | 50 Hz 34W | 2700K | 7272lm built in
upon request 3000K 7560lm
Dimmer: PHASE CUT

100~277 V | 60 Hz 34W | 2700K | 7272lm built in
upon request 3000K 7560lm
Dimmer: PHASE CONTROL & 0-10V
(only 120Vac TRIAC Dimmers)

NET WEIGHT 6,6 kg | 14,6 lb
PESO NETO

PACKAGING 102x102x13 cm | 40,1x40,1x5,1"
EMBALAJE 10 kg | 22 lb

PM06PR-LD

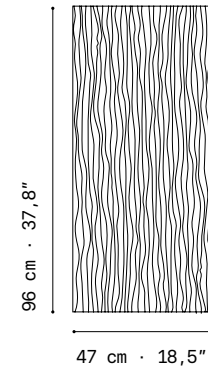

Depth · Profundidad
8 cm | 3,1"

LIGHT SOURCE Light source built in
FUENTE DE LUZ Fuente de luz incluida

230 V | 50 Hz 17W | 2700K | 3636lm built in
upon request 3000K 3780lm
Dimmer: PHASE CUT

100~277 V | 60 Hz 17W | 2700K | 3636lm built in
upon request 3000K 3780lm
Dimmer: PHASE CONTROL & 0-10V
(only 120Vac TRIAC Dimmers)

NET WEIGHT 2,8 kg | 6,2 lb
PESO NETO

PACKAGING 102x53x13 cm | 40,1x20,8x5,1"
EMBALAJE 5 kg | 11 lb

Tati

Arturo Álvarez, 2011

p. 40

MATERIALS Painted stainless steel
MATERIALES Acero inoxidable pintado

Steel gloss nickel- plated
and stainless steel
Acero niquel-satinado y acero
inoxidable

FINISHES White · Blanco
ACABADOS

Beige · Beige

Grey · Gris

Taupe · Topo

Custom · Personalizado

SUPPORT Stainless steel
SOPORTE Acero inoxidable

MOUNTING OPTIONS
OPCIONES DE INSTALACIÓN

Wall lamp
Aplique

SUPPORT Steel gloss nickel- plated
and stainless steel
SOPORTE Acero niquel-satinado y acero
inoxidable

MOUNTING OPTIONS
OPCIONES DE INSTALACIÓN

Wall lamp
Aplique

TA06

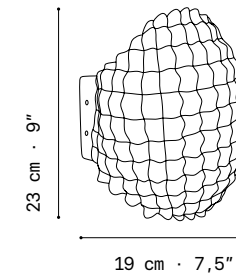

Depth · Profundidad
15 cm | 5,9"

LIGHT SOURCE Recommended bulbs
FUENTE DE LUZ Bombillas recomendadas

230 V | 50 Hz G9 LED - Max. 2x4 W

120 V | 60 Hz G9 LED - Max. 2x4 W

NET WEIGHT 0,5 kg | 1,1 lb
PESO NETO

PACKAGING 25x35x17 cm | 13,7x9,8x6,7"
EMBALAJE 1 kg | 2,2 lb

TA06-LD

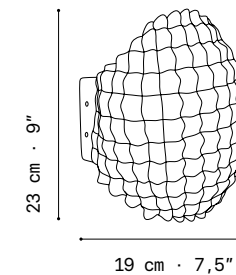

Depth · Profundidad
15 cm | 5,9"

LIGHT SOURCE Light source built in
FUENTE DE LUZ Fuente de luz incluida

230 V | 50 Hz 8W | 2700K | 960lm built in
upon request 3000K 1067lm
Dimmer: PHASE CUT

100~277 V | 60 Hz 8W | 2700K | 960lm built in
upon request 3000K 1067lm
Dimmer: PHASE CONTROL & 0-10V
(only 120Vac TRIAC Dimmers)

NET WEIGHT 0,7 kg | 1,5 lb
PESO NETO

PACKAGING 25x35x17 cm | 13,7x9,8x6,7"
EMBALAJE 1 kg | 2,2 lb

TA06P

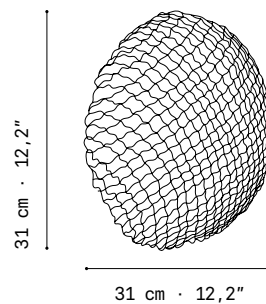

Depth · Profundidad
20 cm | 7,9\"/>

LIGHT SOURCE Recommended bulbs
FUENTE DE LUZ Bombillas recomendadas

230 V | 50 Hz G9 LED - Max. 1x4 W

120 V | 60 Hz G9 LED - Max. 1x4 W

NET WEIGHT 0,8 kg | 1,8 lb
PESO NETO

PACKAGING 36x36x31 cm | 14,2x14,2x12,2\"/>
EMBALAJE 1 kg | 2,2 lb

TA06P-LD

LED

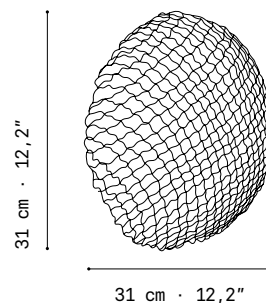

Depth · Profundidad
20 cm | 7,9\"/>

LIGHT SOURCE Light source built in
FUENTE DE LUZ Fuente de luz incluida

230 V | 50 Hz 8W | 2700K | 960lm built in upon request 3000K 1067lm
Dimmer: PHASE CUT

100-277 V | 60 Hz 8W | 2700K | 960lm built in upon request 3000K 1067lm
Dimmer: PHASE CONTROL & 0-10V (only 120Vac TRIAC Dimmers)

NET WEIGHT 1,2 kg | 2,6 lb
PESO NETO

PACKAGING 36x36x31 cm | 14,2x14,2x12,2\"/>
EMBALAJE 1,5 kg | 3,3 lb

TA06G

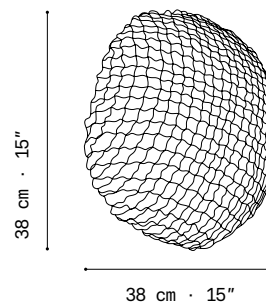

Depth · Profundidad
22 cm | 8,7\"/>

LIGHT SOURCE Recommended bulbs
FUENTE DE LUZ Bombillas recomendadas

230 V | 50 Hz E27 LED Vintage- Max. 2x7 W

120 V | 60 Hz E26 LED - Max. 2x7 W

NET WEIGHT 1 kg | 2,2 lb
PESO NETO

PACKAGING 52x47x31 cm | 20,5x18,5x12,2\"/>
EMBALAJE 2,4 kg | 5,3 lb

TA06G-LD

LED

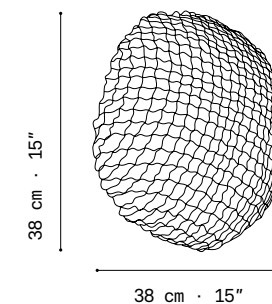

Depth · Profundidad
22 cm | 8,7\"/>

LIGHT SOURCE Light source built in
FUENTE DE LUZ Fuente de luz incluida

230 V | 50 Hz 8W | 2700K | 960lm built in upon request 3000K 1067lm
Dimmer: PHASE CUT

100-277 V | 60 Hz 8W | 2700K | 960lm built in upon request 3000K 1067lm
Dimmer: PHASE CONTROL & 0-10V (only 120Vac TRIAC Dimmers)

NET WEIGHT 1,4 kg | 3,1 lb
PESO NETO

PACKAGING 52x47x31 cm | 20,5x18,5x12,2\"/>
EMBALAJE 2,4 kg | 5,3 lb

Umбра Line

Isaac Piñeiro, 2025

p. 40

MATERIALS Satin stainless steel
MATERIALES Acero inoxidable satinado

Inox steel
Acero Inox

FINISHES White · Blanco

Satin Inox · Inox satinado

SUPPORT Painted steel
SOPORTE Acero pintado

MOUNTING OPTIONS
OPCIONES DE INSTALACIÓN
Wall lamp
Aplique

ULI06S

LED

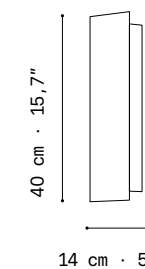

Depth · Profundidad
4,6 cm | 1,8\"/>

LIGHT SOURCE Recommended bulbs
FUENTE DE LUZ Bombillas recomendadas

230 V | 50 Hz 6W | 2700K | 400lm built in
Dimmer: PHASE CUT

100-277 V | 60 Hz 6W | 2700K | 400lm built in
Dimmer: PHASE CONTROL & 0-10V (only 120Vac TRIAC Dimmers)

NET WEIGHT 1,4 kg | 3,1 lb
PESO NETO

PACKAGING 50x20x12 cm | 19,7x8x4,7\"/>
EMBALAJE 2,1 kg | 4,6 lb

ULI06M

LED

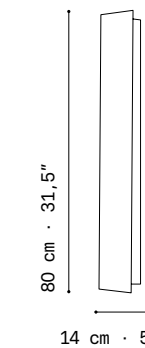

Depth · Profundidad
4,8 cm | 1,9\"/>

LIGHT SOURCE Recommended bulbs
FUENTE DE LUZ Bombillas recomendadas

230 V | 50 Hz 14W | 2700K | 960lm built in
Dimmer: PHASE CUT

100-277 V | 60 Hz 14W | 2700K | 960lm built in
Dimmer: PHASE CONTROL & 0-10V (only 120Vac TRIAC Dimmers)

NET WEIGHT 5,6 kg | 12,3 lb
PESO NETO

PACKAGING 90x20x12 cm | 35,4x8x4,7\"/>
EMBALAJE 3,3 kg | 7,3 lb

ULIO6L

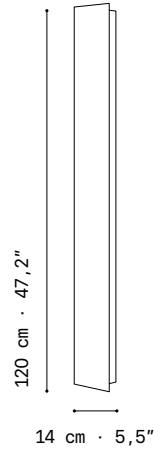

LIGHT SOURCE Recommended bulbs
FUENTE DE LUZ Bombillas recomendadas

230 V | 50 Hz 14W | 2700K | 950 built in
 Dimmer: PHASE CUT

100~277 V | 60 Hz 14W | 2700K | 950 built in
 Dimmer: PHASE CONTROL & 0-10V
 (only 120Vac TRIAC Dimmers)

NET WEIGHT 4,8 kg | 10,6 lb
PESO NETO

PACKAGING 130x20x20 cm | 51,2x8x8"
EMBALAJE 6 kg | 13,2 lb

Depth · Profundidad
4,8 cm | 1,9"

Umbra Round

Isaac Piñeiro, 2025

p. 40

MATERIALS Painted steel
MATERIALES Acero pintado

Painted stainless steel
Acero inoxidable pintado

FINISHES White · Blanco
ACABADOS

Custom · Personalizado

SUPPORT Stainless steel
SOPORTE Acero inoxidable

MOUNTING OPTIONS
OPCIONES DE INSTALACIÓN
Wall lamp
Apilique

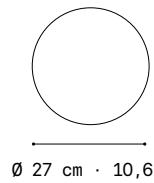

Depth · Profundidad
4,6 cm | 1,8"

URO06S



LIGHT SOURCE Light source built in
FUENTE DE LUZ Fuente de luz incluida

230 V | 50 Hz STRIP 9W | 2700K | 610lm
 built-in Dimmer: PHASE CUT

100~277 V | 60 Hz STRIP 9W | 2700K | 610lm
 Dimmer: 0-10 V

NET WEIGHT 1,1 kg | 2,4 lb
PESO NETO

PACKAGING 44x44x16 cm | 17,3x17,3x6,3"
EMBALAJE 2,1 kg | 4,6 lb

Depth · Profundidad
4,6 cm | 1,8"

URO06M

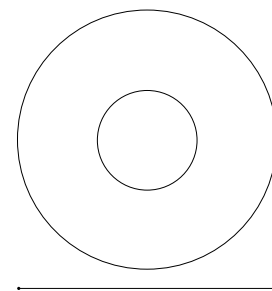

Depth · Profundidad
6,1 cm | 2,4"

LIGHT SOURCE Light source built in
FUENTE DE LUZ Fuente de luz incluida

230 V | 50 Hz STRIP 18W | 2700K | 1220lm
 built-in Dimmer: PHASE CUT

100~277 V | 60 Hz STRIP 18W | 2700K | 1220lm
 Dimmer: 0-10 V

NET WEIGHT 3 kg | 6,6 lb
PESO NETO

PACKAGING 66x32x17 cm | 26x12,6x6,7"
EMBALAJE 3,8 kg | 8,4 lb

URO06L

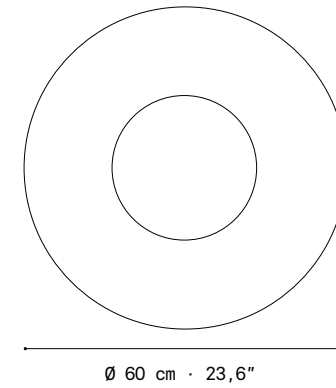

Depth · Profundidad
7,6 cm | 3"

LIGHT SOURCE Light source built in
FUENTE DE LUZ Fuente de luz incluida

230 V | 50 Hz STRIP 24W | 2700K | 1630lm
 built-in Dimmer: PHASE CUT

100~277 V | 60 Hz STRIP 24W | 2700K | 1630lm
 Dimmer: 0-10 V

NET WEIGHT 4,7 kg | 10,4 lb
PESO NETO

PACKAGING 66x32x17 cm | 26x12,6x6,7"
EMBALAJE 6,2 kg | 13,7 lb

Venus

PF1 interiorismo, 2022

p. 40

MATERIALS Painted stainless steel
MATERIALES Acero inoxidable pintado

FINISHES White · Blanco
ACABADOS

Black · Negro

Custom · Personalizado

SUPPORT Painted steel in the same
SOPORTE color that lampshade
Acero pintado en el mismo
color que la tulipa

MOUNTING OPTIONS
OPCIONES DE INSTALACIÓN
Wall lamp
Apilique

VE06

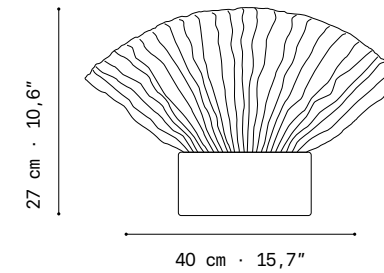

Depth · Profundidad
7 cm | 2,8"

LIGHT SOURCE Light source built in
FUENTE DE LUZ Fuente de luz incluida

230 V | 50 Hz 4W | 2700K | 1060lm built in
 Dimmer: PHASE CUT

100~277 V | 60 Hz 4W | 2700K | 1060lm built in
 Dimmer: PHASE CONTROL & 0-10V
 (only 120Vac TRIAC Dimmers)

NET WEIGHT 1,6 kg | 3,5 lb
PESO NETO

PACKAGING 44x44x20 cm | 17,3x17,3x7,9"
EMBALAJE 2,6 kg | 5,7 lb

Accessories

Accesorios

CANOPY & PIECE TO MOVE THE ELECTRIC CABLE
FLORÓN & PIEZA PARA DESPLAZAMIENTO DE CABLE ELÉCTRICO

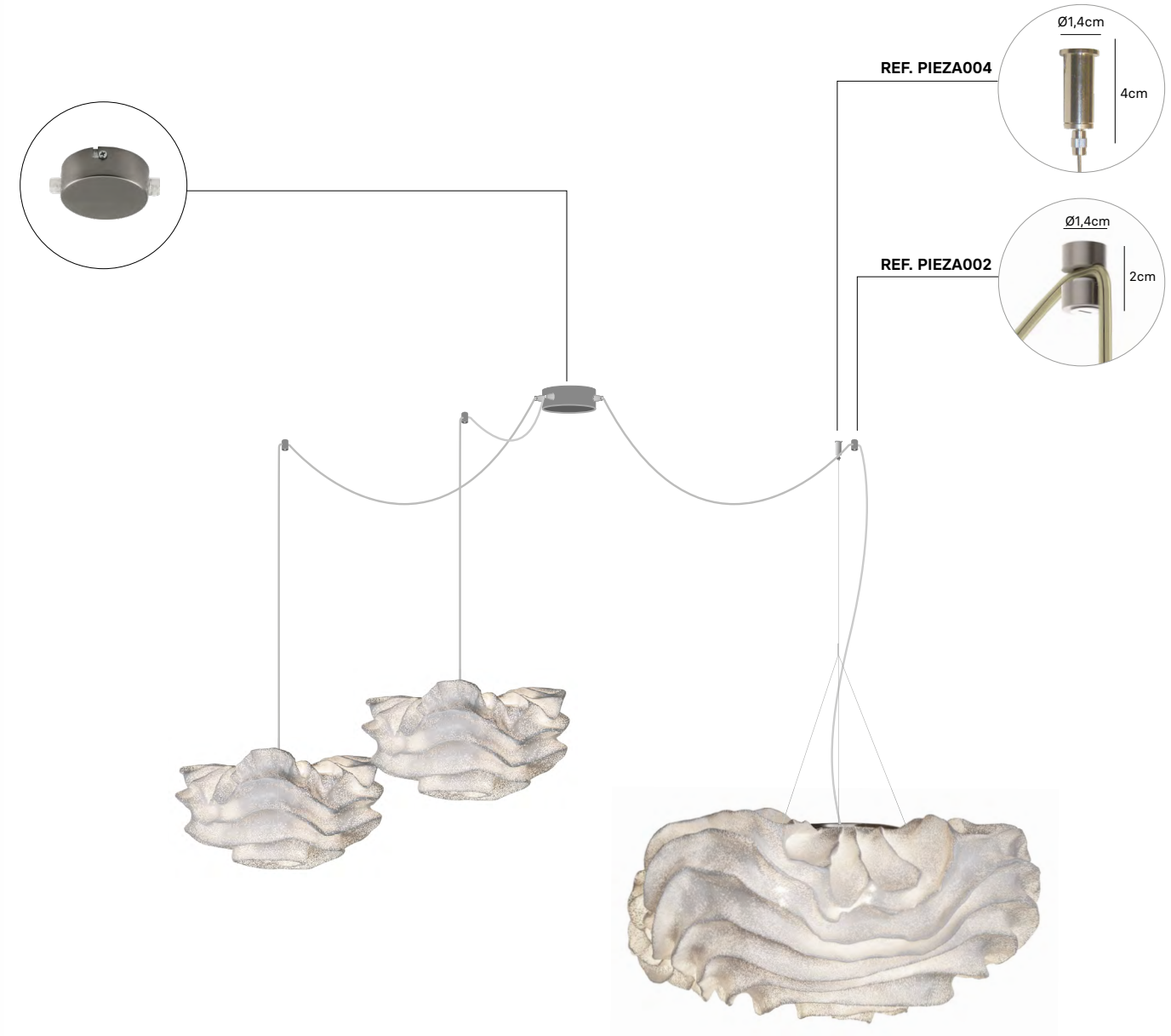

Option for luminaires with electric cable only
Opción para luminarias solamente con cable eléctrico

Option for luminaires with electric and steel cable
Opción para luminarias con cable eléctrico y de acero

REF. PIEZA004
PIECE TO HOLD THE STEEL CABLE
PIEZA PARA SUJECCIÓN DE CABLE DE ACERO

REF. PIEZA002
PIECE TO MOVE THE ELECTRIC CABLE
PIEZA PARA DESPLAZAMIENTO DE CABLE ELÉCTRICO

REF. PIEZA006
FINISH IN BLACK COLOR
ACABADO EN COLOR NEGRO

CANOPY | FLORÓN

Canopy small Ø80mm
Florón pequeño Ø80mm
Finishing nickel-plated
Acabado níquel satinado
Maximum 3 outputs
Máximo 3 salidas



Ref. CAN8

Canopy medium Ø120mm
Florón mediano Ø120mm
Finishing nickel-plated
Acabado níquel satinado



Maximum 8 outputs
Máximo 8 salidas

Ref. CAN12



Finishing black matt
Acabado mate



For compositions
with black cable
Para composiciones
con cable

Ref. CAN-BL

Canopy recessed
Florón empotrado
Finishing matt white
or matt black
Acabado blanco mate
o mate



Ref. CAN-N

Type 1 Tipo 1
One side output
Salida por el lateral
hacia un lado

Type 2 Tipo 2
Around side output
Salida lateral
alrededor

Type 3 Tipo 3
Downward output
Salida hacia abajo

Finishing black matt
Acabado mate

For compositions
with black cable
Para composiciones
con cable

LIGHT BULBS | BOMBILLAS

BASE	DESCRIPCIÓN	W	T (Kelvin)	REF.
E27 LED	Standard vintage Ø60mm	6	2700K 3000K	ELEC0907 ELEC0908
	Standard Dimmable vintage Ø60mm	6	2700K	ELEC0700
	Standard vintage Ø60mm	10	2700K	ELEC2201
E14 LED Round	Round Vintage	4	2700K	ELEC0689
G9 LED	LED bi-pin 230V	4	2700K 3000K	ELEC0703 ELEC0655

Ecodesign standards for lighting products are mandatory for all manufacturers and importers who intend to market their products in the EU. As of September 1, 2021, Regulation (EU) 2019/2020 establishing eco-design requirements for light sources and independent control mechanisms repeals and replaces Regulations (EC) No 244/2009, (EC) No 244/2009, (EC) No 245/2009 and (EU) No 1194/2012.

Las normas de diseño ecológico para los productos de iluminación son obligatorias para todos los fabricantes e importadores que pretendan comercializar sus productos en la UE. Desde el 1 de septiembre de 2021, el Reglamento (UE) 2019/2020 por el que se establecen requisitos de diseño ecológico para las fuentes luminosas y los mecanismos de control independientes deroga y sustituye los Reglamentos (EC) No 244/2009, (CE) n.º 244/2009, (CE) n.º 245/2009 y (UE) n.º 1194/2012.

Headquarters

Calor Color S.L.
C/ Castiñeiras 108A,
15895 O Milladoiro, A Coruña, Spain.
T. +34 981 814 600

a by emotional light inc.
1460 Broadway Ste 6025 New York,
NY 10036 US
T. +1 323 599 6363

info@a-emotionallight.com
www.a-emotionallight.com

©2024 Calor Color S.L.
All rights reserved.

