

# a

## emotional light

ballet collection

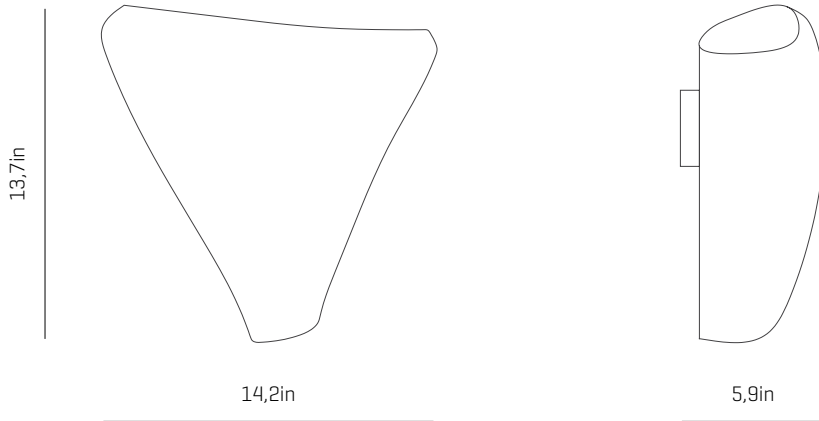

USA & Canada

ref. BA06

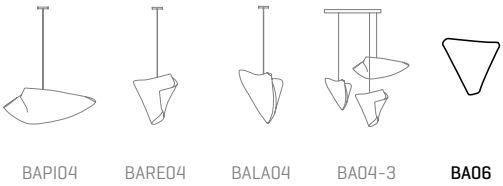

BAPI04

BARE04

BALA04

BA04-3

BA06

### MATERIALS & COMPONENTS

#### LAMPSHADE

Painted stainless steel | One color to choose



BL

BE

G

T

CUSTOM  
COLOR

#### RECOMMENDED BULBS

**120V - 60Hz**

 E26 LED- Max. 1x8 W

### OTHER DATA

#### NET WEIGHT

1,3lb

#### PACKAGING

17,3x 17,3x 7,9in

4,2lb

#### ELECTRICAL FEATURES



#### CERTIFICATIONS



### SUPPORT AND MOUNTING OPTIONS

Painted steel

Wall lamp

## emotional light

ASSEMBLY INSTRUCTIONS  
INSTRUCTIONS DE MONTAGE  
INSTRUCCIONES DE MONTAJE

## Ballet

ref. BA06

Suitable for indoor use, at 77°F

Convient pour une utilisation en intérieur à une température ambiante de 77°F

Apta para uso interior a temperatura ambiente de 77°F

Box contains | Contenu de la boîte | Contenido de la caja:

- A** - Lampshade | Abat jour | Tulipa [1]
- B** - Holding piece | Pièce de fixation | Pieza de sujeción [1]
- C** - Security screws | Vis de sécurité | Tornillos de seguridad [2]
- D** - Canopy | Rosace | Florón [1]
- E** - Electrical disposal | Domino électrique | Ficha [3]
- F** - Screws | Vis | Tornillos [2]
- G** - Wall Plugs | Chevilles | Tacos [2]

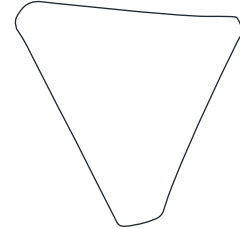

SAFETY NOTE: Switch off mains supply before commencing installation

INFORMATION DE SÉCURITÉ: Débranchez l'alimentation avant de commencer l'installation

INDICACIÓN DE SEGURIDAD: Desconecte la alimentación eléctrica antes de empezar la instalación

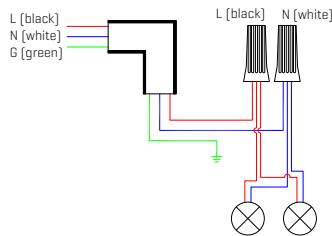
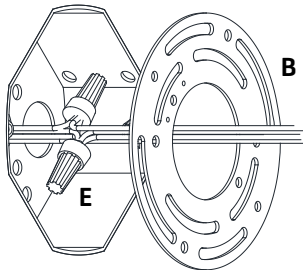

## 1

Pass the electric cables to the interior and do the electric connection inside the octagon box, please follow the instructions.

Passez les câbles électriques à l'intérieur et établissez la connexion électrique à l'intérieur en suivant les instructions.

Pasar los cables eléctricos al interior y hacer la conexión eléctrica dentro de la caja de conexiones, siguiendo las instrucciones.

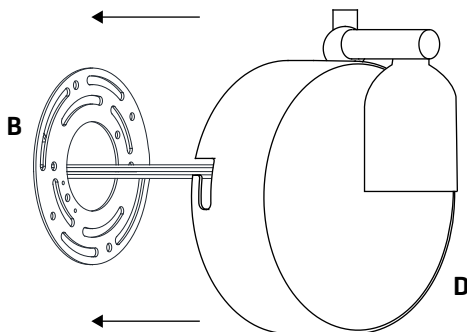

## 2

Fit the bracket onto the bridge, turning it slightly to insert the bridge screws into the keyholes on the bracket.

Montez le support sur le pont, en le tournant légèrement pour insérer les vis du pont dans les trous de serrure du support..

Encajar el soporte en el puente, girándolo levemente para introducir los tornillos del puente en las bocallaves del soporte.

\* Do not separate the lampshade from the support  
\* Ne séparez pas l'abat-jour du support  
\* No separe la tulipa del soporte

## emotional light

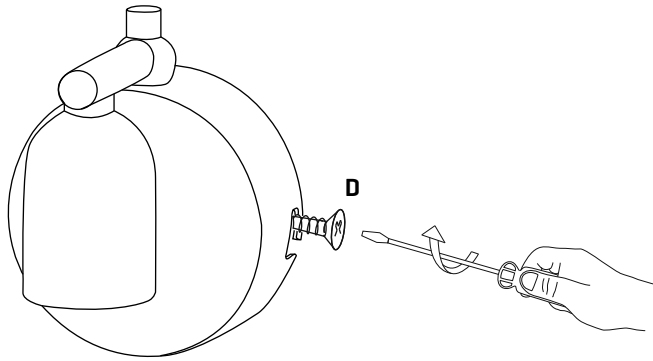

## 3

Join the shade to the base, by screwing a pair of screws on each side.

Fixez la tulipe au support en vissant la paire de vis de chaque côté.

Unir la tulipa en el soporte, atornillando la pareja de tornillos de cada lado.

The device is not suitable for installation on normally inflammable surfaces.



Dispositif non adapté à une installation sur des surfaces normalement inflammables.

Aparato no adaptado para la instalación en superficies normalmente inflamables.