

a

emotional light

gea collection

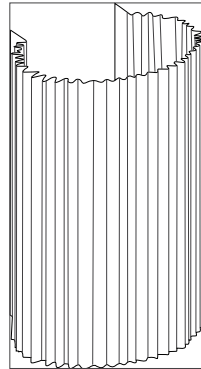

26cm | 10,2in

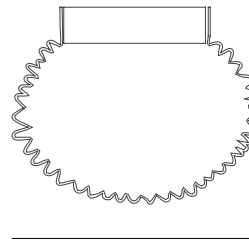

13cm | 5,1in

16cm | 6,3in

ref. GE06



GE03



GE04



GE06

MATERIALS & COMPONENTS | MATERIALES & COMPONENTES

LAMP SHADE | TULIPA

Painted stainless steel | One color to choose
Acero inoxidable pintado | Un color a elegir



BL

BE

G

T

CUSTOM
COLOR

RECOMMENDED BULBS

BOMBILLAS RECOMENDADAS

230V - 50Hz

 G9 LED - Max. 2x4 W

120V - 60Hz

 G9 LED - Max. 2x4 W

OTHER DATA | OTROS DATOS

NET WEIGHT | PESO NETO

0,6kg | 1,3lb

PACKAGING | EMBALAJE

34x24x15cm | 13,4x 9,4x 5,9in

1kg | 2,2lb

ELECTRICAL FEATURES

CARACTERÍSTICAS ELÉCTRICAS



CERTIFICATIONS

CERTIFICACIONES



SUPPORT AND MOUNTING OPTIONS

SOORTE Y OPCIONES DE INSTALACIÓN

Stainless steel
Acero inoxidable

Wall lamp
Aplique

Gea

ref. GE06

Suitable for indoor use, at 25°C

Apta para uso interior a temperatura ambiente de 25°C

Box contains | Contenido de la caja:

A - Lampshade | Tulipa [1]

B - Holding piece | Pieza de sujeción [1]

C - Lampholder | Portalámparas [1]

D - Security screws | Tornillos de seguridad [2]

E - Electrical disposal | Ficha [1]

F - Screws | Tornillos [2]

G - Wall Plugs | Tacos [2]

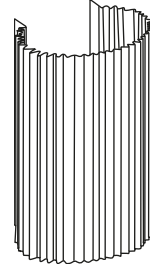

SAFETY NOTE: Switch off mains supply before commencing installation

INDICACIÓN DE SEGURIDAD : Desconecte la alimentación eléctrica antes de empezar la instalación

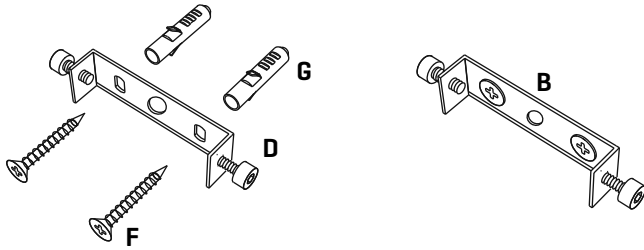

1

Drill the holes in the wall, fit the wall plugs into them and screw the holding piece.

Realizar los agujeros en la pared, colocar los tacos y atornillar la pieza de sujeción.

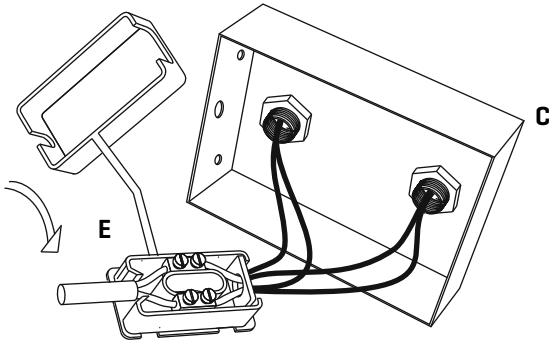

2

Pass the electric cables inside the metal support through the black protection tube, make the electrical connection in the box [E] and close it.

Pasar los cables eléctricos al interior del soporte metálico por el tubo negro de protección, hacer la conexión eléctrica en la ficha [E] y cerrarla.

a

emotional light

ASSEMBLY INSTRUCTIONS
INSTRUCCIONES DE MONTAJE

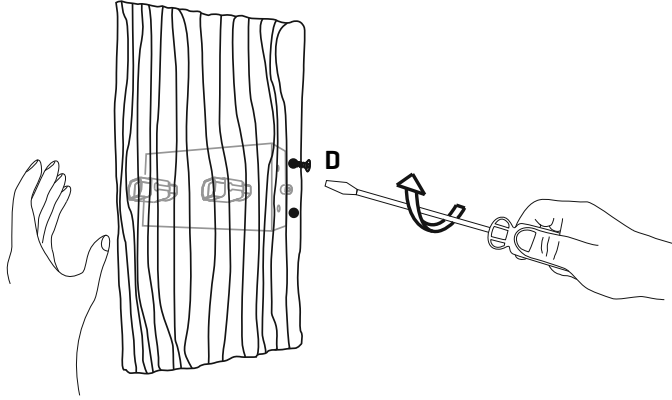

3

Join the shade to the base, by screwing a pair of screws on each side.

Unir la tulipa en el soporte, atornillando la pareja de tornillos de cada lado.



The device is not suitable for installation on normally inflammable surfaces.

Aparato no adaptado para la instalación en superficies normalmente inflamables.